

Lag 1 Skive 1

# Valnesfjordstevnet 2024 - Østb

Ingvar Thomas Sørfjord  
Sørfjord og Omegn

Klasse V65  
427

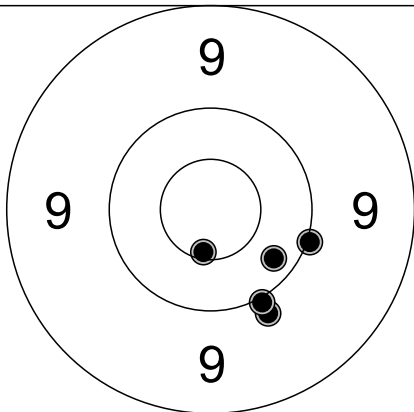

1	X.1	→	
2	*.7	↓	
3	9.9	↓	
4	X.0	↓	
5	X.3	↘	

Serie 1  
S-10: 49                      SUM: 49 (1)                      TOT: 49 (1)

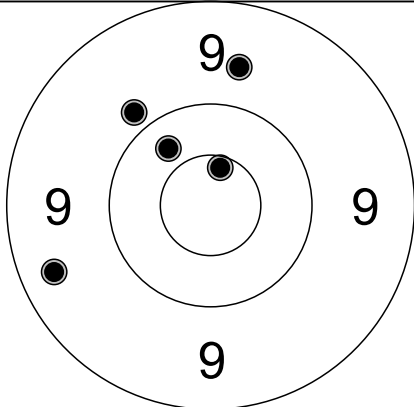

1	9.7	↑	
2	*.7	↑	
3	X.4	↖	
4	9.9	↖	
5	9.4	←	

Serie 2  
S-10: 47                      SUM: 47 (1)                      TOT: 96 (2)

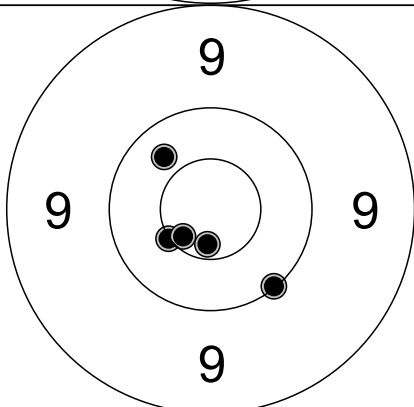

1	X.1	↓	
2	*.6	↙	
3	*.7	↙	
4	X.4	↖	
5	*.7	↓	

Serie 3  
S-10: 50                      SUM: 50 (3)                      TOT: 146 (5)

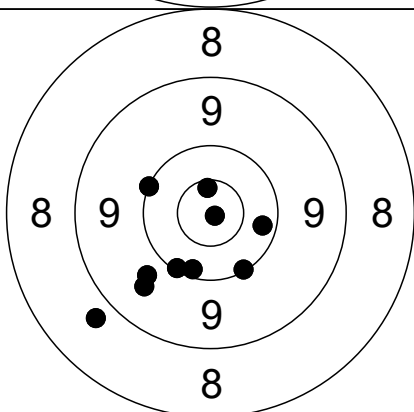

1	*.9	↘		6	9.8	↙	
2	X.3	→		7	8.8	↙	
3	X.1	↓		8	9.6	↙	
4	X.2	↓		9	X.1	↖	
5	*.7	↑		10	X.1	↙	

10-skudd  
S-10: 96                      SUM: 96 (2)                      TOT: 242 (7)

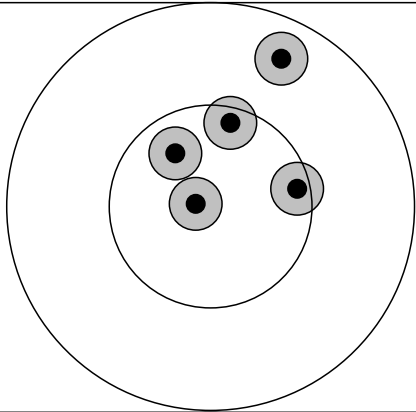

1	*.9	←	
2	*.8	↖	
3	*.7	→	
4	X.3	↗	
5	*.7	↗	

Serie 1  
S-10: 50                      SUM: 50 (4)                      TOT: 50 (4)

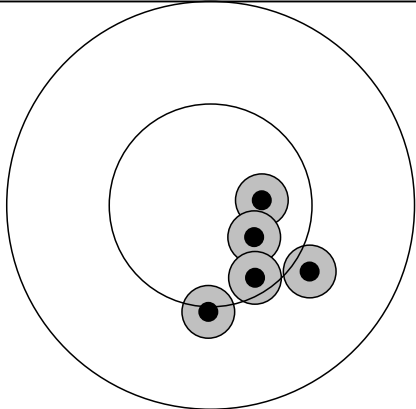

1	*.8	→	
2	*.6	↓	
3	*.5	↘	
4	*.8	↘	
5	*.7	↘	

Serie 2  
S-10: 50                      SUM: 50 (5)                      TOT: 100 (9)

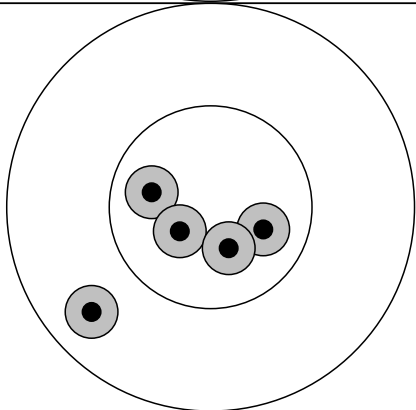

1	X.3	↖	
2	*.8	←	
3	*.9	↖	
4	*.8	→	
5	*.9	↘	

Serie 3  
S-10: 50                      SUM: 50 (4)                      TOT: 150 (13)

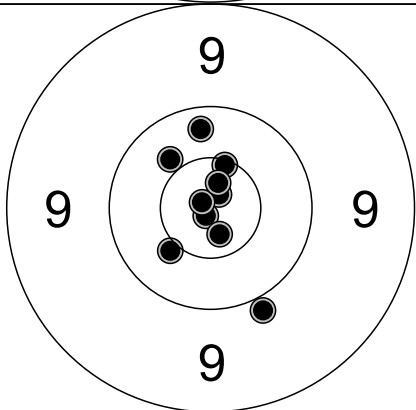

1	*.9	↘	6	X.3	↗	
2	*.9	↗	7	*.8	↗	
3	*.6	↗	8	*.5	↖	
4	*.5	↖	9	*.8	↓	
5	*.9	↖	10	X.0	↓	

10-skudd  
S-10: 100                      SUM: 100 (8)                      TOT: 250 (21)

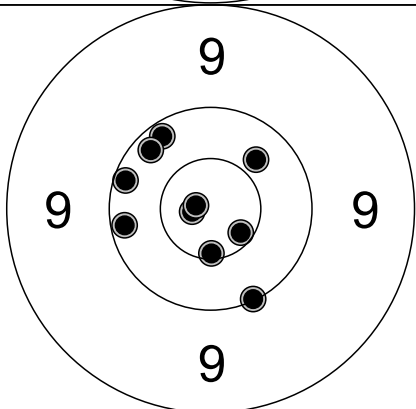

1	X.2	↖	6	X.3	↖	
2	*.9	←	7	*.6	↓	
3	X.1	↓	8	X.2	↖	
4	*.7	↘	9	X.4	↗	
5	*.9	←	10	X.2	←	

Omgang  
S-10: 100                      SUM: 100 (4)                      TOT: 350 (25)

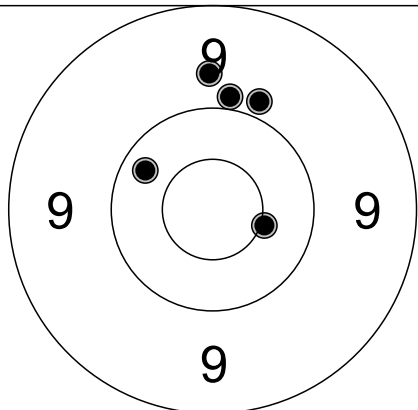

1	9.8	↑	
2	*.6	→	
3	9.9	↑	
4	X.0	↑	
5	X.3	←	

Serie 1  
S-10: 48                      SUM: 48 (1)                      TOT: 48 (1)

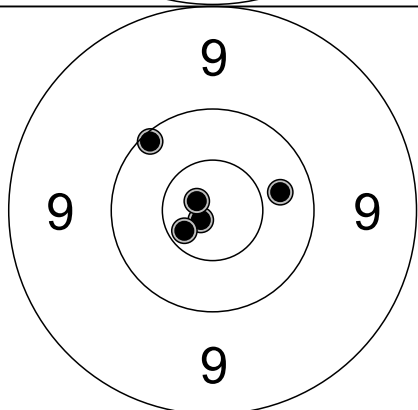

1	X.2	↖	
2	*.9	↙	
3	*.7	↙	
4	X.4	→	
5	*.9	↖	

Serie 2  
S-10: 50                      SUM: 50 (3)                      TOT: 98 (4)

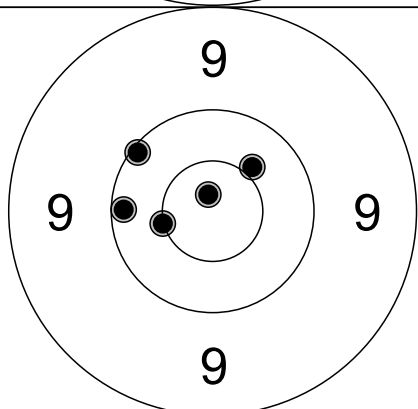

1	*.9	↑	
2	X.2	←	
3	X.2	↖	
4	*.5	↗	
5	*.6	←	

Serie 3  
S-10: 50                      SUM: 50 (3)                      TOT: 148 (7)

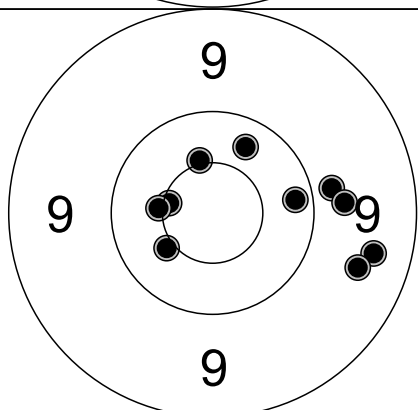

1	9.9	→	6	9.8	→
2	9.5	→	7	X.4	↗
3	*.5	↙	8	*.6	↑
4	*.6	←	9	9.6	→
5	*.6	←	10	X.3	→

10-skudd  
S-10: 96                      SUM: 96 (4)                      TOT: 244 (11)

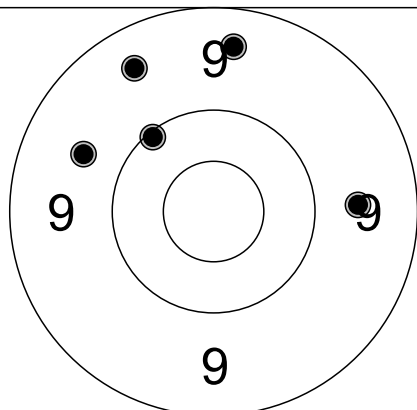

1	9.5	↖	
2	9.5	↑	
3	9.7	→	
4	9.7	↖	
5	X.1	↖	

Serie 1  
S-10: 46                      SUM: 46 (0)                      TOT: 46 (0)

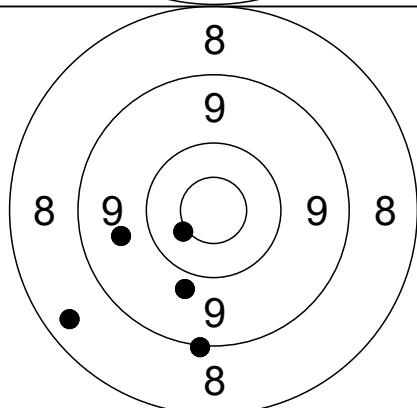

1	8.4	↖	
2	9.9	↓	
3	9.1	↓	
4	9.7	←	
5	*.5	↖	

Serie 2  
S-10: 45                      SUM: 45 (1)                      TOT: 91 (1)

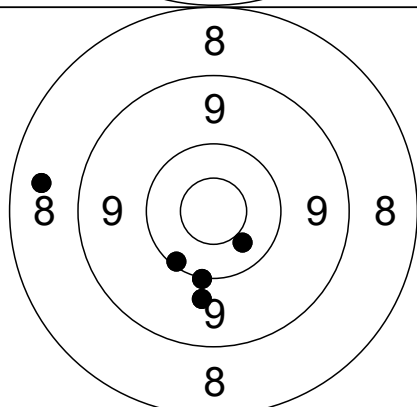

1	8.5	←	
2	X.1	↓	
3	X.2	↖	
4	*.5	↘	
5	9.8	↓	

Serie 3  
S-10: 47                      SUM: 47 (1)                      TOT: 138 (2)

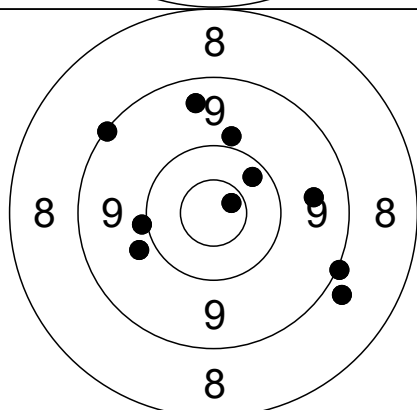

1	9.6	→	6	9.1	↖
2	9.1	→	7	9.9	↑
3	9.5	↑	8	9.9	←
4	8.9	↘	9	X.3	↗
5	X.0	←	10	*.8	↗

10-skudd  
S-10: 92                      SUM: 92 (1)                      TOT: 230 (3)

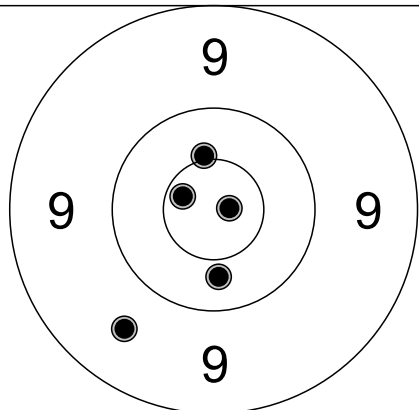

1	X.4	↓	
2	9.6	↙	
3	*.9	→	
4	*.5	↑	
5	*.8	←	

Serie 1  
S-10: 49 SUM: 49 (3) TOT: 49 (3)

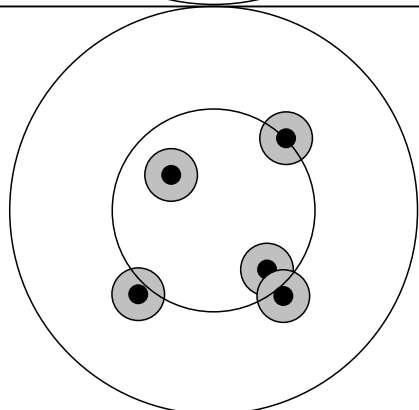

1	*.8	↗	
2	*.7	↓	
3	*.5	↙	
4	*.6	↗	
5	*.5	↓	

Serie 2  
S-10: 50 SUM: 50 (5) TOT: 99 (8)

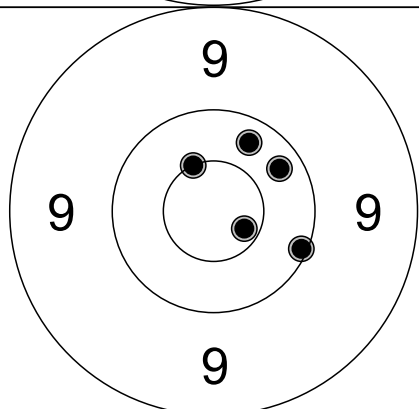

1	*.7	↘	
2	X.2	→	
3	X.3	↑	
4	*.6	↑	
5	X.3	↗	

Serie 3  
S-10: 50 SUM: 50 (2) TOT: 149 (10)

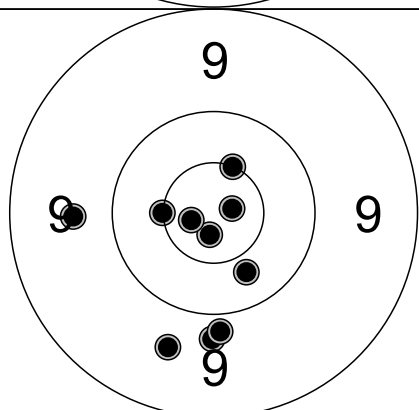

1	9.9	↓	6	9.9	↓
2	*.9	↓	7	*.9	→
3	*.9	←	8	*.6	←
4	9.7	↓	9	*.6	↑
5	9.7	←	10	X.4	↓

10-skudd  
S-10: 96 SUM: 96 (5) TOT: 245 (15)

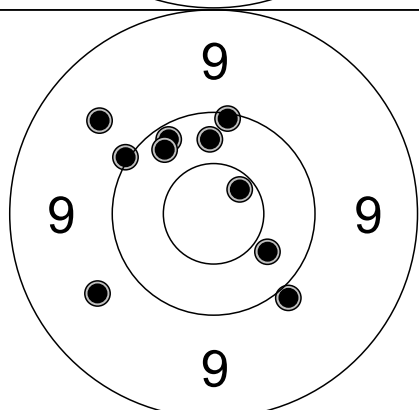

1	X.2	↗	6	X.3	↖
2	9.7	↖	7	X.4	↑
3	X.4	↘	8	X.1	↑
4	9.6	↗	9	X.0	↓
5	X.1	↖	10	*.7	↗

Omgang  
S-10: 98 SUM: 98 (1) TOT: 343 (16)

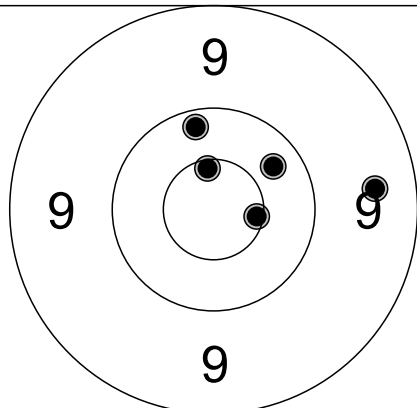

1	X.4	↗	
2	X.3	↑	
3	9.5	→	
4	*.7	→	
5	*.7	↑	

Serie 1  
S-10: 49                      SUM: 49 (2)                      TOT: 49 (2)

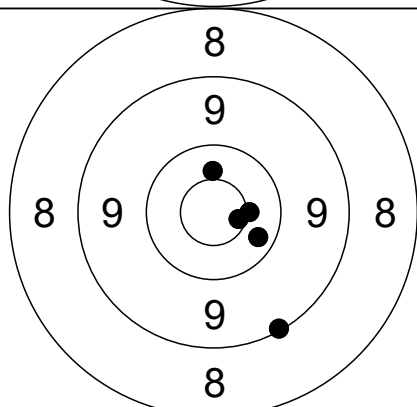

1	*.7	→	
2	9.1	↘	
3	*.5	↑	
4	*.6	→	
5	X.3	↘	

Serie 2  
S-10: 49                      SUM: 49 (3)                      TOT: 98 (5)

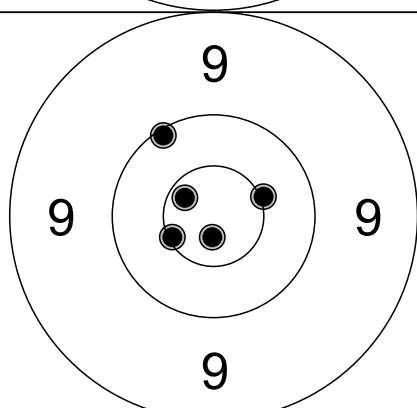

1	X.2	↖	
2	*.6	→	
3	*.6	←	
4	*.8	↖	
5	*.9	↓	

Serie 3  
S-10: 50                      SUM: 50 (4)                      TOT: 148 (9)

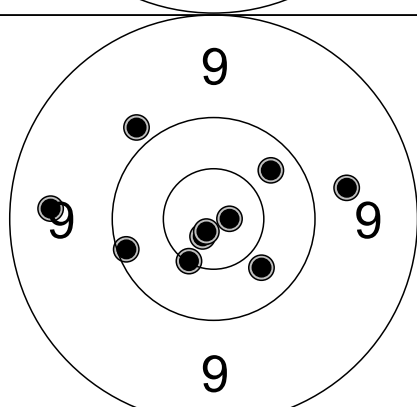

1	*.9	↘	6	X.4	↘
2	X.4	↗	7	9.5	←
3	*.9	↘	8	X.2	←
4	*.6	↘	9	9.9	↗
5	9.7	→	10	*.9	→

10-skudd  
S-10: 97                      SUM: 97 (4)                      TOT: 245 (13)

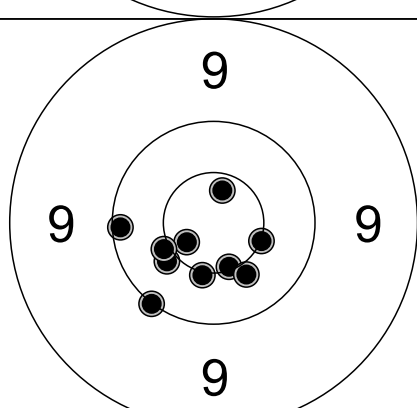

1	X.2	←	6	*.5	↘
2	*.6	↓	7	*.8	↘
3	*.6	↓	8	*.6	→
4	X.1	↘	9	*.5	↘
5	*.8	↑	10	*.5	↖

Omgang  
S-10: 100                      SUM: 100 (8)                      TOT: 345 (21)

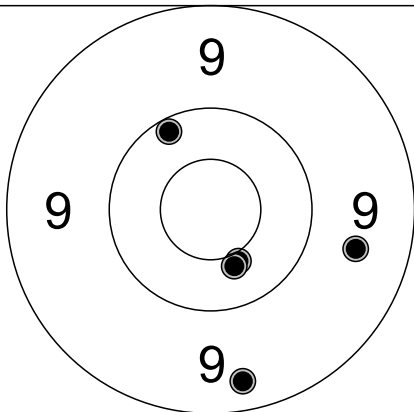

1	*.5	↓	
2	*.5	↓	
3	9.4	↓	
4	X.2	↗	
5	9.6	→	

Serie 1  
S-10: 48                      SUM: 48 (2)                      TOT: 48 (2)

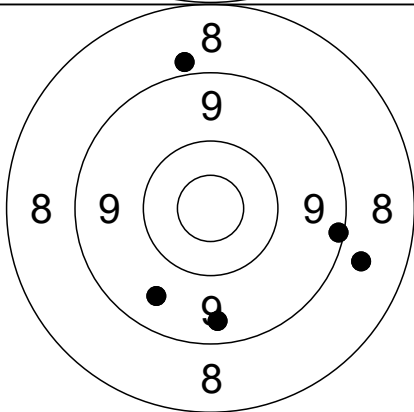

1	8.9	↑	
2	8.7	→	
3	9.6	↓	
4	9.2	→	
5	9.4	↓	

Serie 2  
S-10: 43                      SUM: 43 (0)                      TOT: 91 (2)

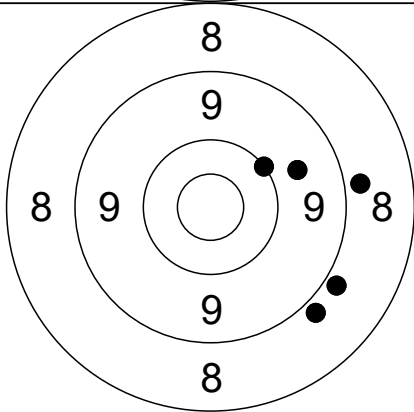

1	8.9	↘	
2	X.1	↗	
3	9.7	→	
4	8.9	↓	
5	8.9	→	

Serie 3  
S-10: 43                      SUM: 43 (0)                      TOT: 134 (2)

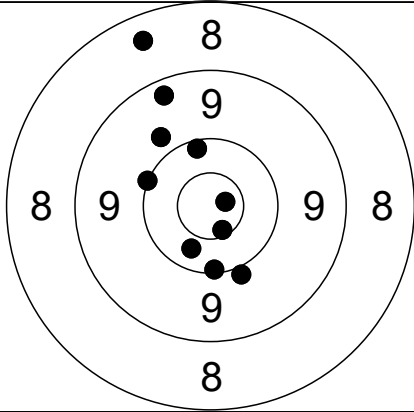

1	X.4	↓	6	X.1	↖
2	X.2	↑	7	8.5	↑
3	X.0	↓	8	9.3	↑
4	9.8	↗	9	*.7	↓
5	X.2	↓	10	*.9	→

10-skudd  
S-10: 96                      SUM: 96 (2)                      TOT: 230 (4)

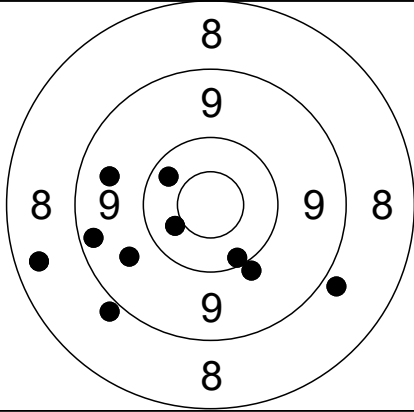

1	*.5	↖	6	8.4	↖
2	8.9	↘	7	9.3	↖
3	9.5	↖	8	9.7	↖
4	X.2	↓	9	8.9	↖
5	9.9	↓	10	X.3	↖

Omgang  
S-10: 90                      SUM: 90 (1)                      TOT: 320 (5)

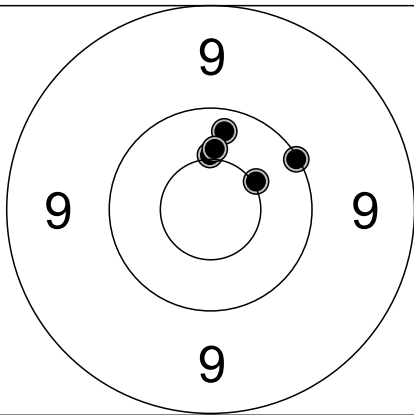

1	X.3	↑	
2	*.6	↑	
3	*.5	↑	
4	*.6	↗	
5	X.1	↗	

Serie 1  
S-10: 50      SUM: 50 (3)      TOT: 50 (3)

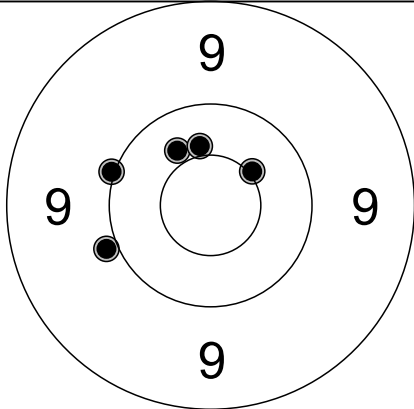

1	*.6	↗	
2	*.5	↖	
3	X.0	←	
4	*.5	↑	
5	X.1	←	

Serie 2  
S-10: 50      SUM: 50 (3)      TOT: 100 (6)

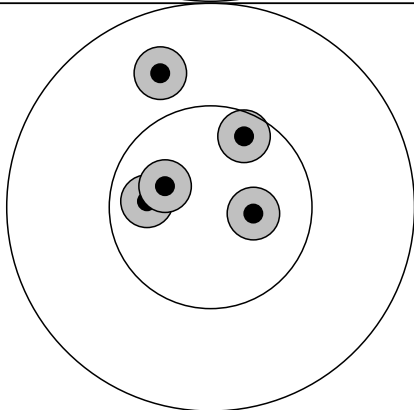

1	*.8	←	
2	*.8	↖	
3	*.7	↑	
4	X.4	↑	
5	*.9	→	

Serie 3  
S-10: 50      SUM: 50 (4)      TOT: 150 (10)

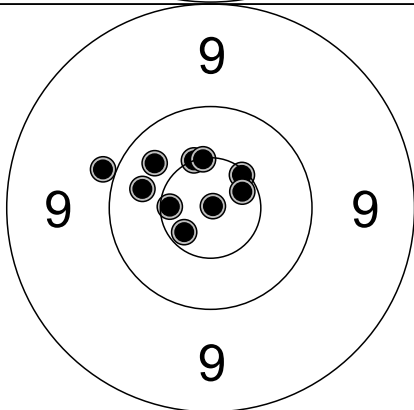

1	*.6	↑	6	*.6	↑
2	X.0	←	7	*.7	←
3	*.7	↙	8	*.9	○
4	*.6	↗	9	X.4	←
5	*.7	↗	10	X.4	↖

10-skudd  
S-10: 100      SUM: 100 (7)      TOT: 250 (17)

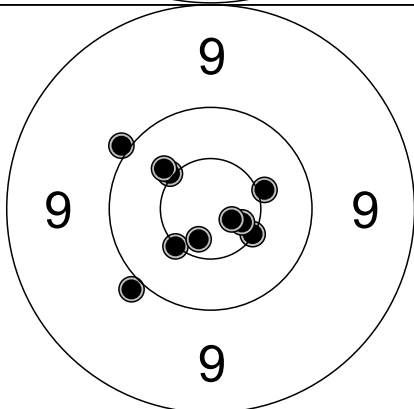

1	*.6	↖	6	*.8	↘
2	*.5	↖	7	*.9	↘
3	X.0	↖	8	*.5	↗
4	*.6	↙	9	*.8	↙
5	*.6	↘	10	X.0	↙

Omgang  
S-10: 100      SUM: 100 (8)      TOT: 350 (25)



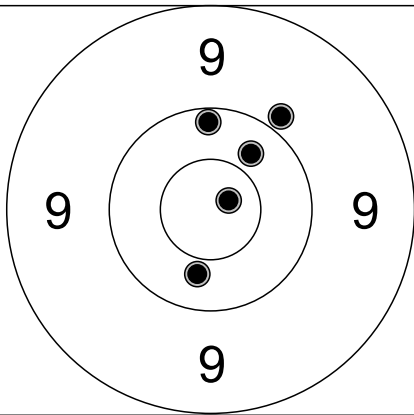

1	X.4	↗	
2	9.9	↗	
3	X.4	↓	
4	*.9	↗	
5	X.2	↑	

Serie 1  
S-10: 49 SUM: 49 (1) TOT: 49 (1)

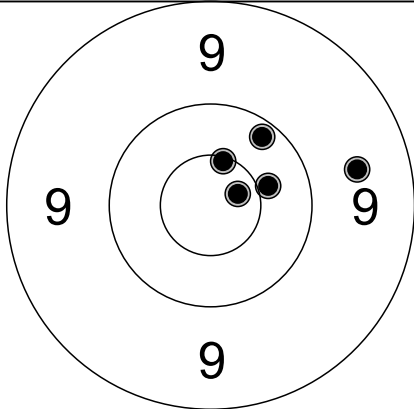

1	9.6	→	
2	*.8	→	
3	*.6	↑	
4	*.5	→	
5	X.2	↗	

Serie 2  
S-10: 49 SUM: 49 (3) TOT: 98 (4)

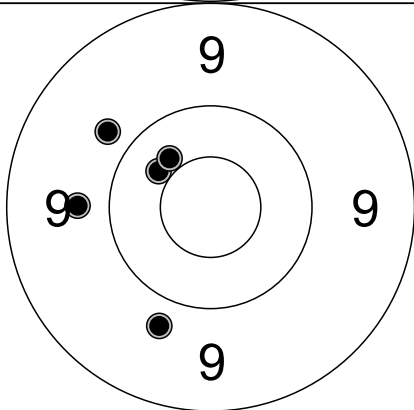

1	*.5	↖	
2	9.8	↖	
3	*.5	↖	
4	9.8	←	
5	9.8	↓	

Serie 3  
S-10: 47 SUM: 47 (2) TOT: 145 (6)

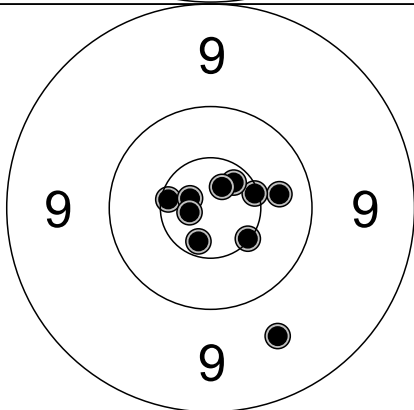

1	X.4	→	6	*.8	↗	
2	*.6	→	7	*.7	←	
3	*.6	↘	8	*.7	↓	
4	9.7	↓	9	*.9	↖	
5	*.7	↗	10	*.9	←	

10-skudd  
S-10: 99 SUM: 99 (8) TOT: 244 (14)

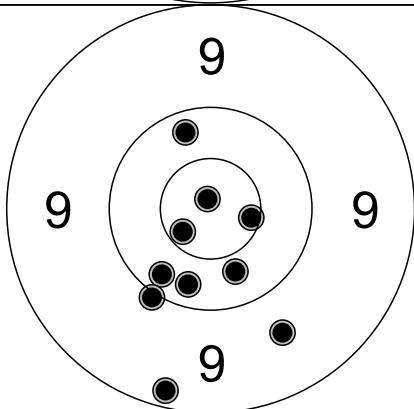

1	*.7	→	6	9.7	↓	
2	*.9	↑	7	X.4	↓	
3	X.3	↓	8	9.3	↓	
4	*.7	↖	9	X.3	↖	
5	X.3	↑	10	X.0	↖	

Omgang  
S-10: 98 SUM: 98 (3) TOT: 342 (17)

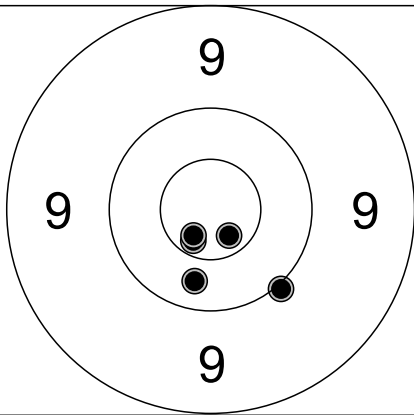

1	X.0	↓	
2	*.8	↓	
3	X.4	↓	
4	*.7	↓	
5	*.8	↓	

Serie 1  
S-10: 50                      SUM: 50 (3)                      TOT: 50 (3)

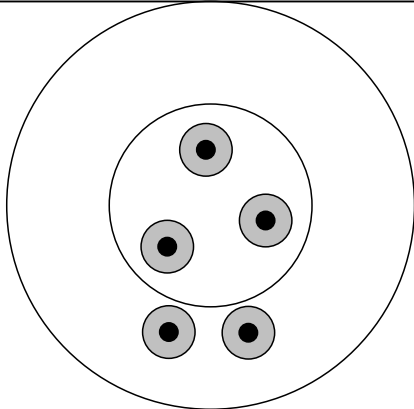

1	X.4	↓	
2	*.8	↙	
3	*.8	→	
4	X.4	↓	
5	*.8	↑	

Serie 2  
S-10: 50                      SUM: 50 (3)                      TOT: 100 (6)

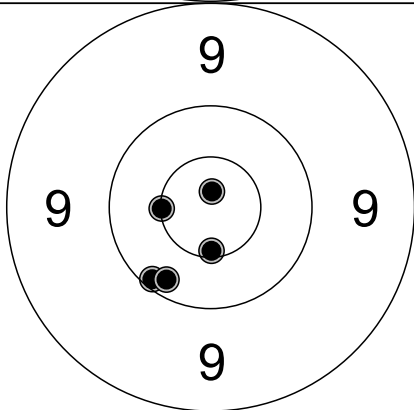

1	*.9	↑	
2	*.6	←	
3	X.2	↙	
4	*.7	↓	
5	X.3	↙	

Serie 3  
S-10: 50                      SUM: 50 (3)                      TOT: 150 (9)

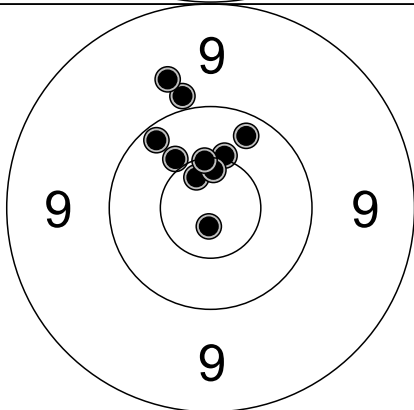

1	*.6	↑	6	X.2	↖	
2	*.5	↖	7	X.3	↗	
3	*.8	↑	8	*.9	↓	
4	*.7	↑	9	*.6	↑	
5	X.0	↑	10	9.8	↑	

10-skudd  
S-10: 99                      SUM: 99 (6)                      TOT: 249 (15)

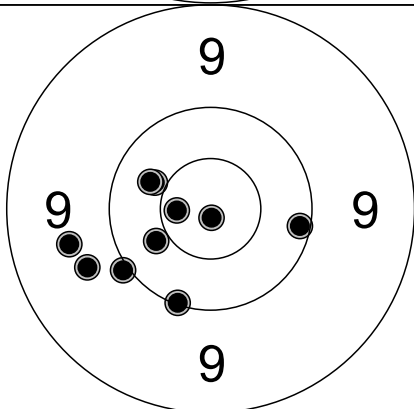

1	*.5	↙	6	X.4	↖	
2	9.7	←	7	X.1	↓	
3	*.5	↖	8	X.2	→	
4	9.8	↙	9	*.8	←	
5	X.0	↙	10	*.9	↓	

Omgang  
S-10: 98                      SUM: 98 (4)                      TOT: 347 (19)

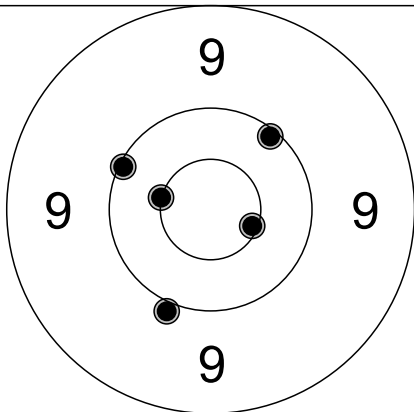

1	X.1	↖	
2	*.6	→	
3	*.6	←	
4	X.0	↓	
5	X.2	↗	

Serie 1  
S-10: 50                      SUM: 50 (2)                      TOT: 50 (2)

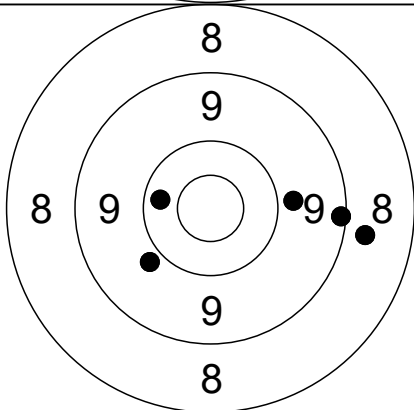

1	9.9	→	
2	9.9	↙	
3	9.2	→	
4	8.8	→	
5	X.3	←	

Serie 2  
S-10: 45                      SUM: 45 (0)                      TOT: 95 (2)

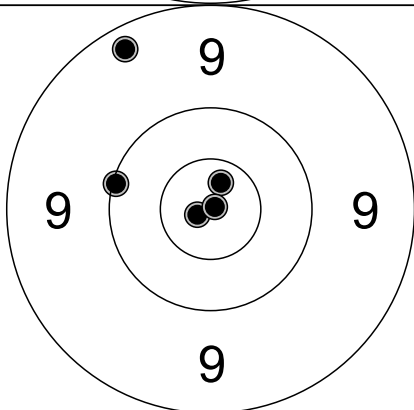

1	9.3	↖	
2	*.8	↖	
3	*.9	←	
4	X.1	←	
5	*.9	↗	

Serie 3  
S-10: 49                      SUM: 49 (3)                      TOT: 144 (5)

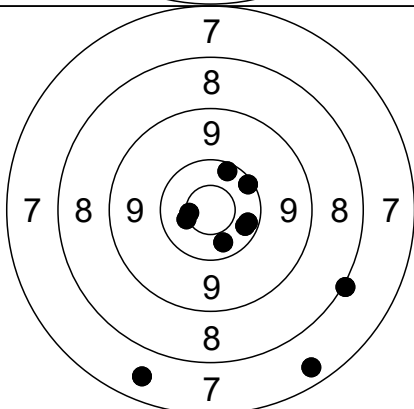

1	7.6	↓	6	8.1	→
2	X.4	↓	7	X.3	↖
3	7.4	↓	8	X.3	→
4	X.3	→	9	*.6	←
5	X.2	↗	10	*.7	←

10-skudd  
S-10: 92                      SUM: 92 (2)                      TOT: 236 (7)

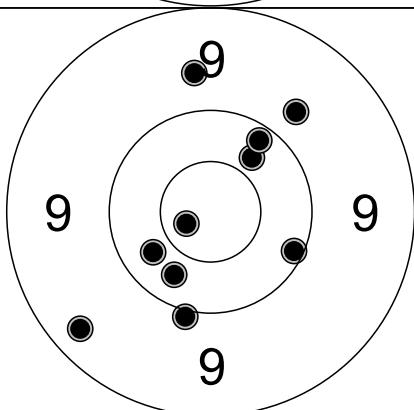

1	9.7	↖	6	X.4	↗
2	9.4	↙	7	X.2	↖
3	X.2	→	8	9.8	↖
4	X.4	←	9	*.8	←
5	X.4	↓	10	X.0	↓

Omgang  
S-10: 97                      SUM: 97 (1)                      TOT: 333 (8)

Lag 3 Skive 5

Valnesfjordstevnet 2024 - Østb

Mathias Barli  
Bodø Østre

Klasse R  
432

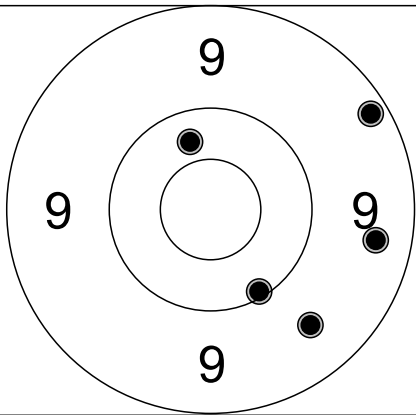

1	X.4	↑	
2	9.3	↗	
3	9.4	→	
4	9.6	↘	
5	X.2	↘	

Serie 1  
S-10: 47 SUM: 47 (0) TOT: 47 (0)

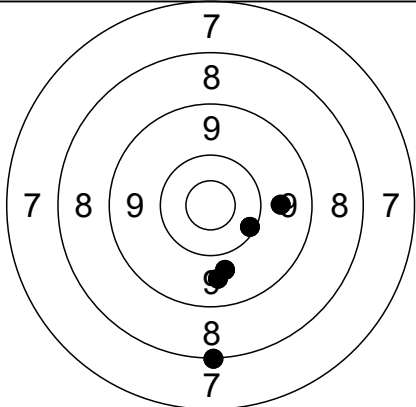

1	9.6	↓	
2	9.7	→	
3	8.1	↓	
4	9.8	↓	
5	X.2	↗	

Serie 2  
S-10: 45 SUM: 45 (0) TOT: 92 (0)

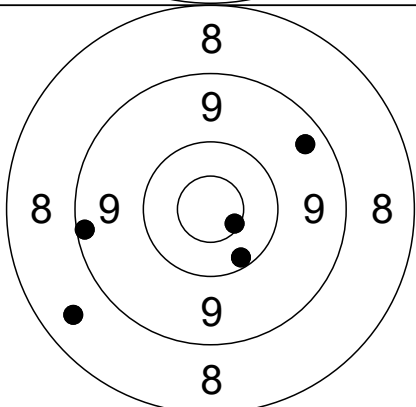

1	9.2	←	
2	8.5	↙	
3	9.4	↗	
4	*.7	↘	
5	X.2	↘	

Serie 3  
S-10: 46 SUM: 46 (1) TOT: 138 (1)

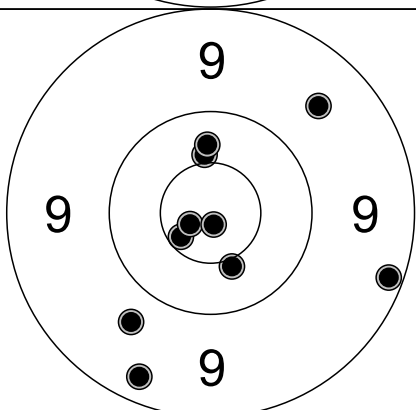

1	*.7	↙	6	9.2	→
2	9.6	↗	7	9.3	↘
3	*.9	←	8	*.5	↓
4	9.8	↘	9	*.9	↓
5	*.5	↑	10	X.4	↑

10-skudd  
S-10: 96 SUM: 96 (5) TOT: 234 (6)

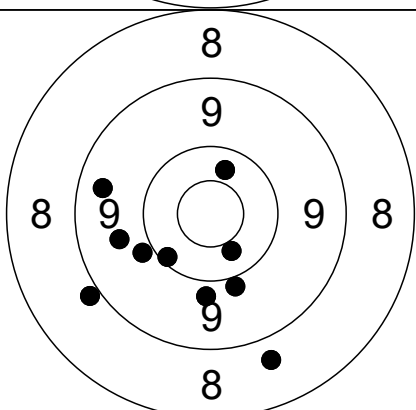

1	8.8	↓	6	9.5	←
2	9.9	↓	7	9.9	↙
3	*.5	↓	8	8.9	↙
4	X.0	↓	9	9.7	←
5	X.4	↑	10	X.2	↙

Omgang  
S-10: 92 SUM: 92 (1) TOT: 326 (7)

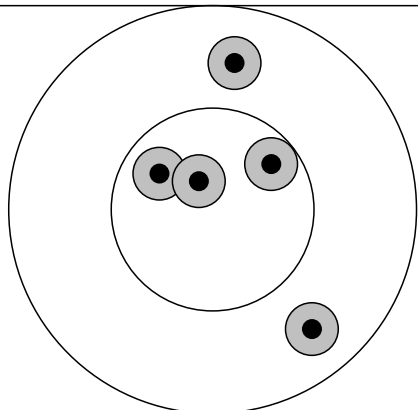

1	X.4	↑	
2	*.7	↗	
3	X.3	↘	
4	*.8	↖	
5	*.9	↑	

Serie 1  
S-10: 50                      SUM: 50 (3)                      TOT: 50 (3)

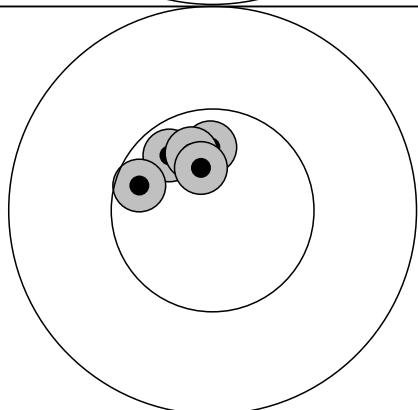

1	*.8	↑	
2	*.7	↖	
3	*.7	←	
4	*.8	↑	
5	*.9	↑	

Serie 2  
S-10: 50                      SUM: 50 (5)                      TOT: 100 (8)

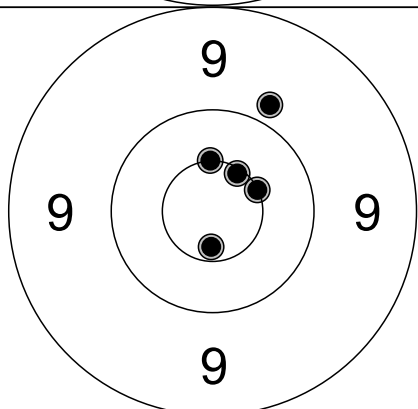

1	*.6	↗	
2	*.7	↓	
3	*.6	↑	
4	9.9	↑	
5	*.6	↖	

Serie 3  
S-10: 49                      SUM: 49 (4)                      TOT: 149 (12)

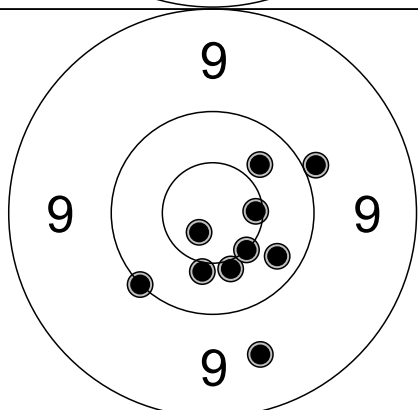

1	X.3	↘	6	X.4	↗
2	*.5	↓	7	X.1	↙
3	*.5	↓	8	*.9	↙
4	*.6	↘	9	*.7	→
5	X.0	↗	10	9.6	↓

10-skudd  
S-10: 99                      SUM: 99 (5)                      TOT: 248 (17)

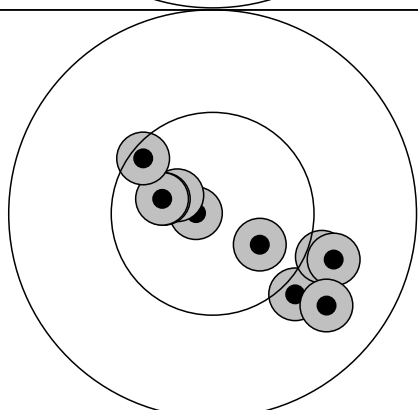

1	*.9	←	6	*.5	↘
2	*.5	↘	7	*.8	↖
3	*.8	↘	8	*.5	↘
4	*.9	↖	9	X.4	↘
5	*.8	←	10	*.7	↖

Omgang  
S-10: 100                      SUM: 100 (9)                      TOT: 348 (26)

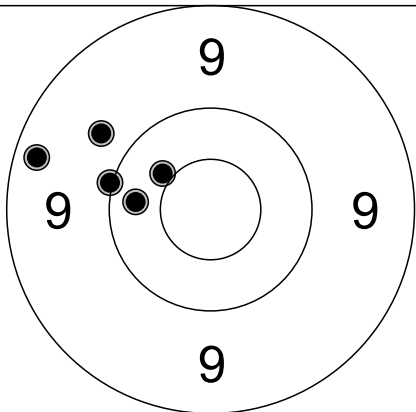

1	X.3	←	
2	9.3	←	
3	X.1	←	
4	*.5	↗	
5	9.8	↖	

Serie 1  
S-10: 48                      SUM: 48 (1)                      TOT: 48 (1)

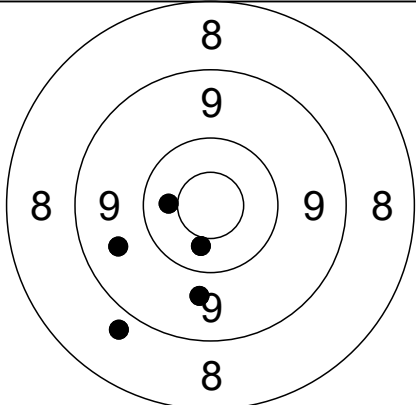

1	*.5	←	
2	*.5	↓	
3	9.6	←	
4	8.8	↙	
5	9.7	↓	

Serie 2  
S-10: 46                      SUM: 46 (2)                      TOT: 94 (3)

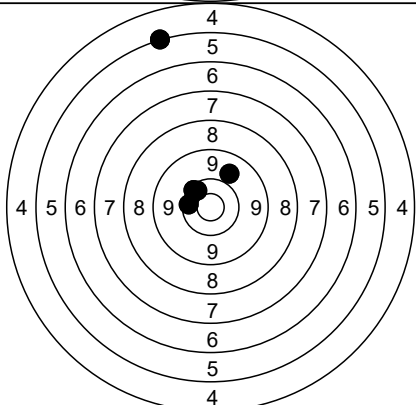

1	X.3	←	
2	9.8	↗	
3	5.1	↗	
4	X.4	↖	
5	X.3	↖	

Serie 3  
S-10: 44                      SUM: 44 (0)                      TOT: 138 (3)

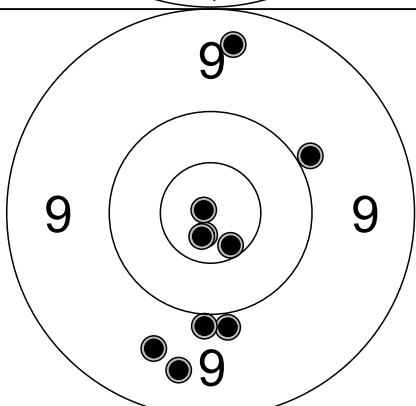

1	X.0	↗	6	X.0	↓
2	9.5	↓	7	9.4	↑
3	*.9	↓	8	*.8	↓
4	9.6	↓	9	X.0	↓
5	*.9	←	10	*.7	↘

10-skudd  
S-10: 97                      SUM: 97 (4)                      TOT: 235 (7)

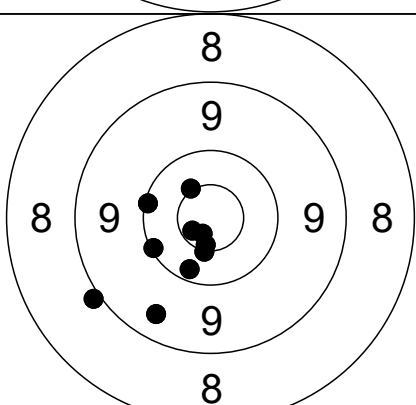

1	*.6	↖	6	X.1	←
2	*.7	↓	7	9.5	↙
3	9.0	←	8	X.3	↓
4	X.1	←	9	*.8	←
5	*.6	↓	10	*.8	↙

Omgang  
S-10: 98                      SUM: 98 (5)                      TOT: 333 (12)

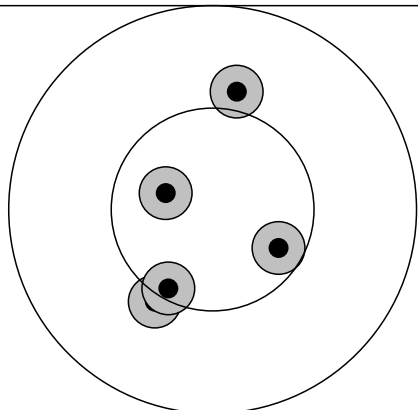

1	*.5	↑	
2	*.6	↙	
3	*.7	→	
4	*.6	↙	
5	*.8	←	

Serie 1  
S-10: 50                      SUM: 50 (5)                      TOT: 50 (5)

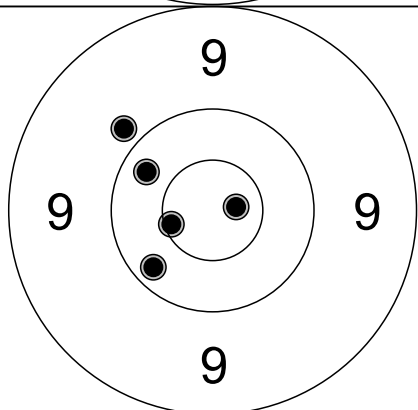

1	*.7	←	
2	X.3	↙	
3	X.3	↖	
4	9.9	↗	
5	*.9	→	

Serie 2  
S-10: 49                      SUM: 49 (2)                      TOT: 99 (7)

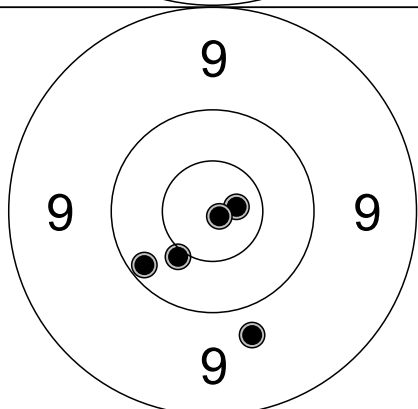

1	*.8	→	
2	*.9	↘	
3	X.2	↙	
4	9.8	↓	
5	*.5	↙	

Serie 3  
S-10: 49                      SUM: 49 (3)                      TOT: 148 (10)

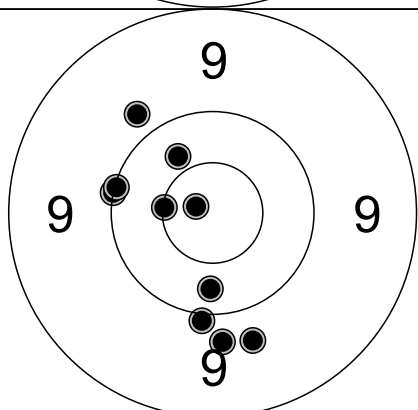

1	X.0	↓	6	9.9	↗
2	9.8	↓	7	X.1	←
3	X.3	↓	8	X.4	↗
4	*.6	←	9	*.9	←
5	X.1	←	10	9.8	↓

10-skudd  
S-10: 97                      SUM: 97 (2)                      TOT: 245 (12)

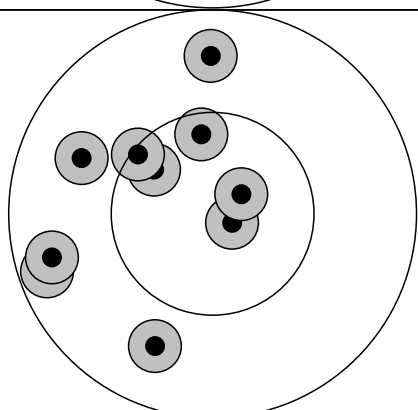

1	X.4	↙	6	X.2	←
2	*.7	↑	7	*.6	↖
3	*.9	→	8	X.3	←
4	*.7	↖	9	X.4	←
5	X.3	↑	10	*.9	↗

Omgang  
S-10: 100                      SUM: 100 (5)                      TOT: 345 (17)

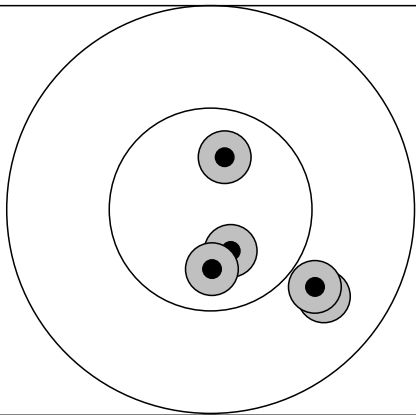

1	*.8	↑	
2	X.4	↘	
3	*.9	↓	
4	X.4	↘	
5	*.8	↓	

Serie 1  
S-10: 50                      SUM: 50 (3)                      TOT: 50 (3)

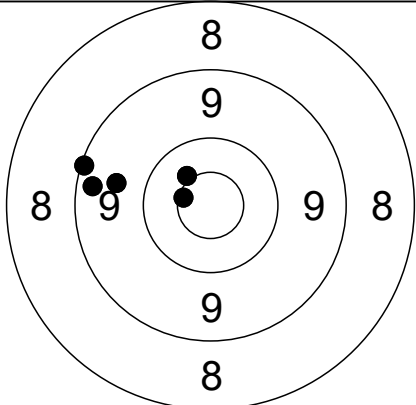

1	9.3	←	
2	9.1	←	
3	9.7	←	
4	*.5	↑	
5	*.7	←	

Serie 2  
S-10: 47                      SUM: 47 (2)                      TOT: 97 (5)

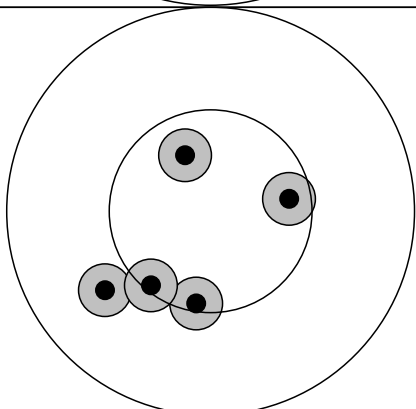

1	*.8	↑	
2	*.7	→	
3	X.4	↙	
4	*.6	↓	
5	*.6	↙	

Serie 3  
S-10: 50                      SUM: 50 (4)                      TOT: 147 (9)

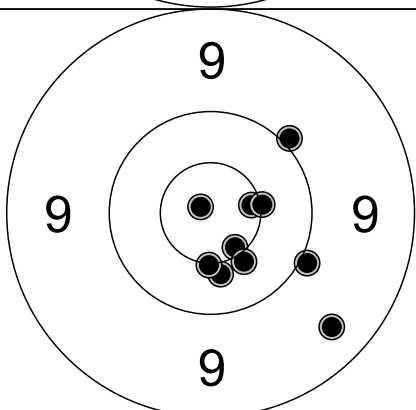

1	*.7	→	6	X.0	↘	
2	X.0	↗	7	9.5	↘	
3	*.9	↖	8	*.5	↓	
4	*.7	↓	9	*.6	↓	
5	*.6	→	10	*.5	↓	

10-skudd  
S-10: 99                      SUM: 99 (7)                      TOT: 246 (16)

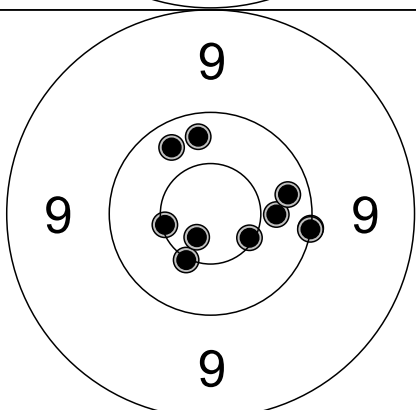

1	X.1	→	6	X.4	→	
2	*.6	←	7	X.3	↗	
3	*.6	↘	8	*.8	↘	
4	*.6	↘	9	X.3	→	
5	X.1	→	10	X.3	↑	

Omgang  
S-10: 100                      SUM: 100 (4)                      TOT: 346 (20)



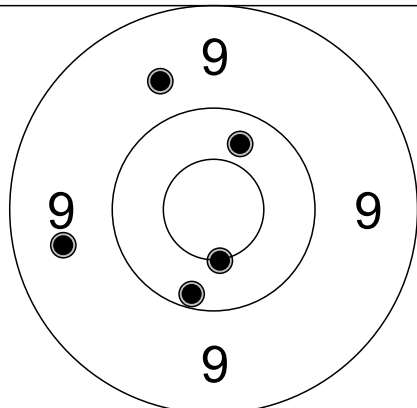

1	*.6	↓	
2	X.4	↑	
3	9.6	←	
4	9.7	↑	
5	X.2	↓	

Serie 1  
S-10: 48                      SUM: 48 (1)                      TOT: 48 (1)

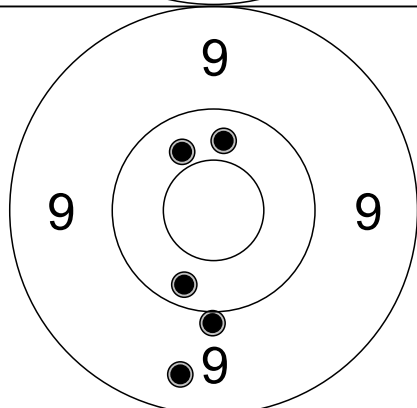

1	X.0	↓	
2	X.4	↑	
3	X.3	↓	
4	X.4	↑	
5	9.4	↓	

Serie 2  
S-10: 49                      SUM: 49 (0)                      TOT: 97 (1)

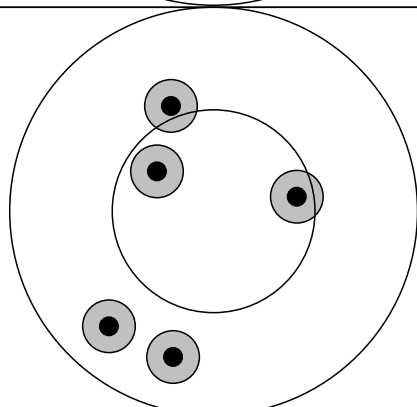

1	*.5	↑	
2	X.3	↓	
3	X.3	↙	
4	*.7	→	
5	*.7	↖	

Serie 3  
S-10: 50                      SUM: 50 (3)                      TOT: 147 (4)

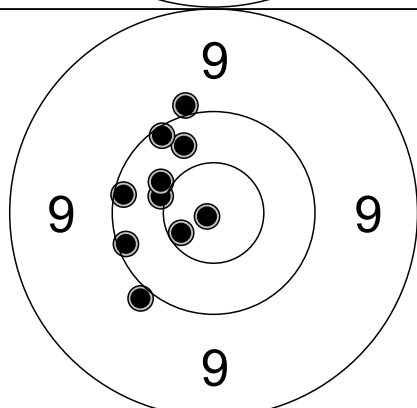

1	*.9	↙	6	*.7	↙
2	X.0	↙	7	*.5	↙
3	X.4	↑	8	*.5	↖
4	X.2	↑	9	X.2	↙
5	X.0	↑	10	X.2	↙

10-skudd  
S-10: 100                      SUM: 100 (4)                      TOT: 247 (8)

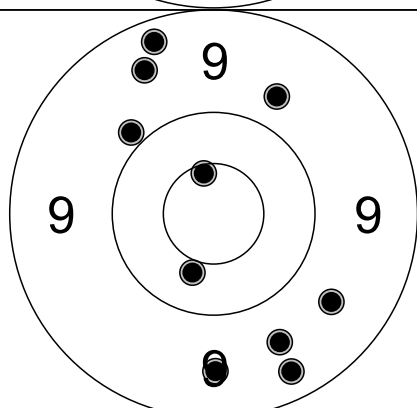

1	9.8	↑	6	9.5	↓
2	X.0	↖	7	9.7	↓
3	9.6	↘	8	*.7	↑
4	9.3	↑	9	*.5	↓
5	9.5	↑	10	9.4	↓

Omgang  
S-10: 93                      SUM: 93 (2)                      TOT: 340 (10)

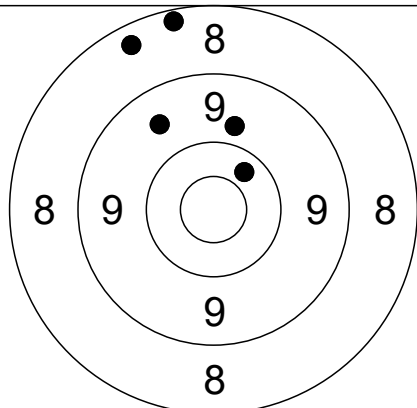

1	8.3	↑	
2	8.4	↑	
3	X.4	↗	
4	9.6	↑	
5	9.8	↑	

Serie 1  
S-10: 44                      SUM: 44 (0)                      TOT: 44 (0)

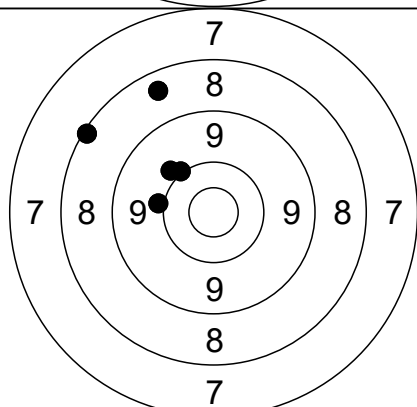

1	8.5	↑	
2	8.2	↖	
3	9.9	↑	
4	X.0	←	
5	X.1	↑	

Serie 2  
S-10: 45                      SUM: 45 (0)                      TOT: 89 (0)

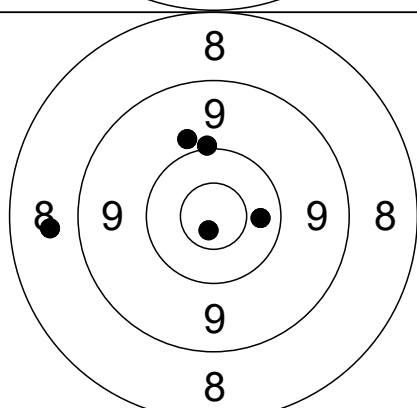

1	8.7	←	
2	9.9	↑	
3	X.0	↑	
4	*.9	↓	
5	X.4	→	

Serie 3  
S-10: 47                      SUM: 47 (1)                      TOT: 136 (1)

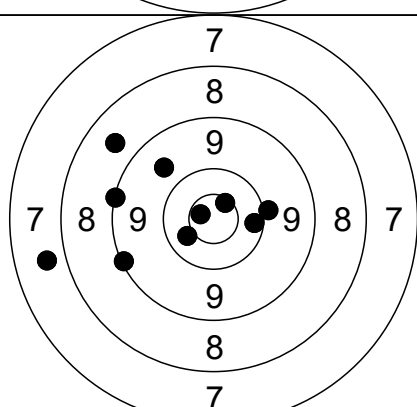

1	*.7	↗	6	9.7	↖
2	7.7	←	7	9.1	←
3	9.1	←	8	X.3	→
4	*.8	←	9	X.0	→
5	8.7	↖	10	*.5	↙

10-skudd  
S-10: 92                      SUM: 92 (3)                      TOT: 228 (4)

Lag 5 Skive 3

# Valnesfjordstevnet 2024 - Østb

Mikael Nicolai Danielsen  
Halsa (Salten)

Klasse J  
298

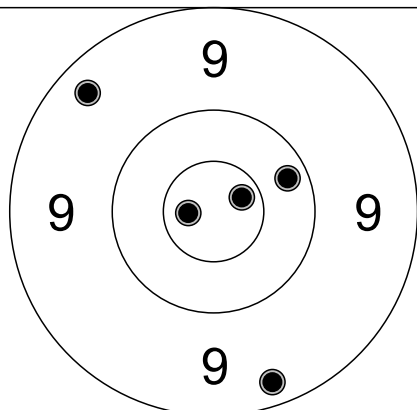

1	*.8	←	
2	X.3	→	
3	9.4	↖	
4	9.3	↓	
5	*.8	→	

Serie 1  
S-10: 48      SUM: 48 (2)      TOT: 48 (2)

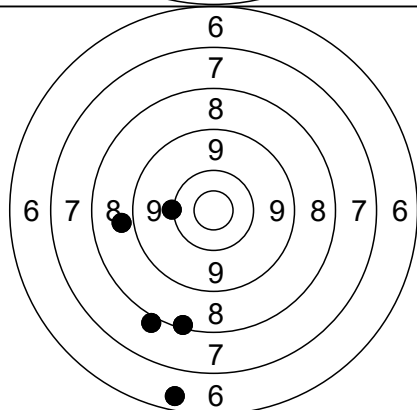

1	7.9	↓	
2	X.1	←	
3	8.8	←	
4	8.2	↓	
5	6.5	↓	

Serie 2  
S-10: 39      SUM: 39 (0)      TOT: 87 (2)

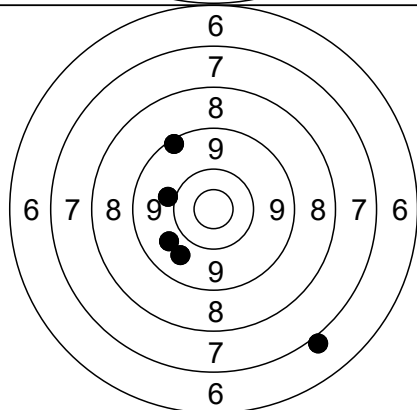

1	9.7	↓	
2	9.9	←	
3	9.2	↖	
4	9.7	←	
5	6.9	↓	

Serie 3  
S-10: 42      SUM: 42 (0)      TOT: 129 (2)

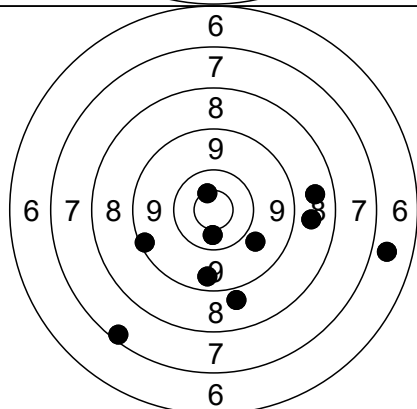

1	8.8	↓	6	9.2	←
2	9.8	↘	7	6.7	→
3	9.5	↓	8	8.6	→
4	8.7	→	9	*.5	↓
5	7.3	↙	10	*.6	↖

10-skudd  
S-10: 84      SUM: 84 (2)      TOT: 213 (4)

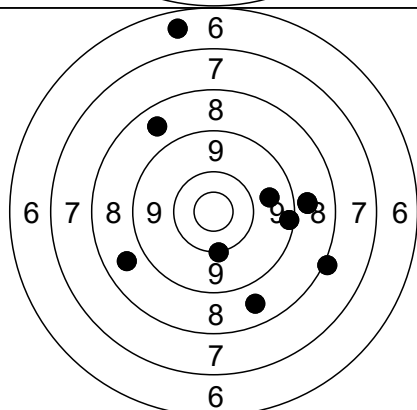

1	6.5	↑	6	8.0	↘
2	8.6	↓	7	X.1	↓
3	8.6	↖	8	8.8	→
4	8.6	←	9	9.2	→
5	9.7	→	10	8.8	→

Omgang  
S-10: 82      SUM: 82 (0)      TOT: 295 (4)

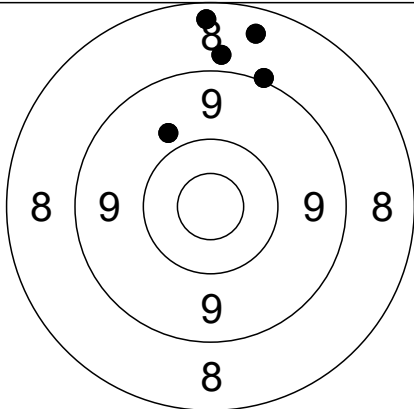

1	9.0	↗	
2	8.9	↑	
3	8.3	↑	
4	8.5	↑	
5	9.8	↖	

Serie 1  
S-10: 42                      SUM: 42 (0)                      TOT: 42 (0)

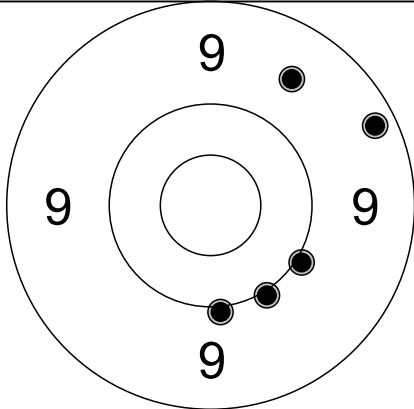

1	9.3	→	
2	X.0	↓	
3	9.6	↗	
4	X.0	↓	
5	X.0	↘	

Serie 2  
S-10: 48                      SUM: 48 (0)                      TOT: 90 (0)

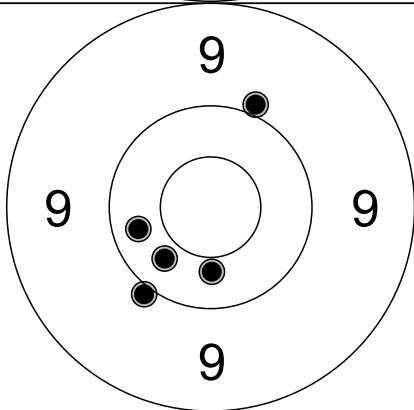

1	*.5	↓	
2	X.0	↗	
3	X.3	←	
4	X.0	↙	
5	X.4	↙	

Serie 3  
S-10: 50                      SUM: 50 (1)                      TOT: 140 (1)

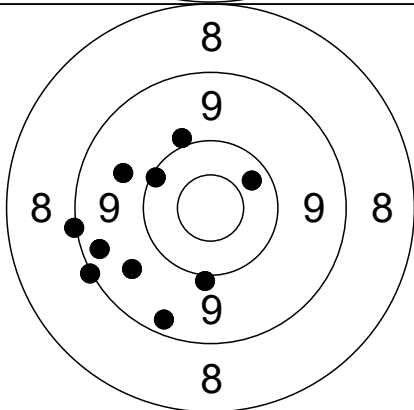

1	X.4	↗	6	9.3	↓	
2	X.0	↖	7	9.1	←	
3	X.0	↓	8	9.4	←	
4	9.1	←	9	X.2	↖	
5	9.6	↙	10	9.7	←	

10-skudd  
S-10: 94                      SUM: 94 (0)                      TOT: 234 (1)

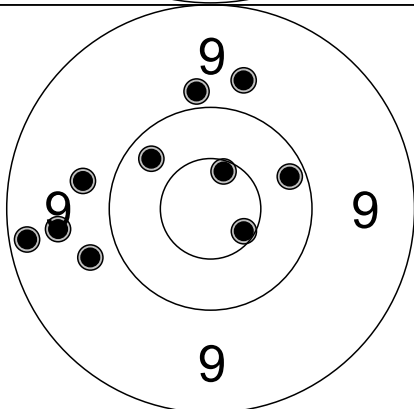

1	9.8	↑	6	X.3	↖	
2	9.8	←	7	X.2	↗	
3	*.7	↘	8	9.6	←	
4	*.7	↑	9	9.3	←	
5	9.8	←	10	9.9	↑	

Omgang  
S-10: 94                      SUM: 94 (2)                      TOT: 328 (3)

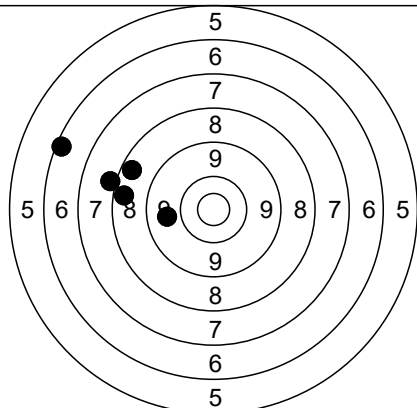

1	9.7	←	
2	6.3	↖	
3	8.4	←	
4	8.4	↖	
5	7.9	←	

Serie 1  
S-10: 38                      SUM: 38 (0)                      TOT: 38 (0)

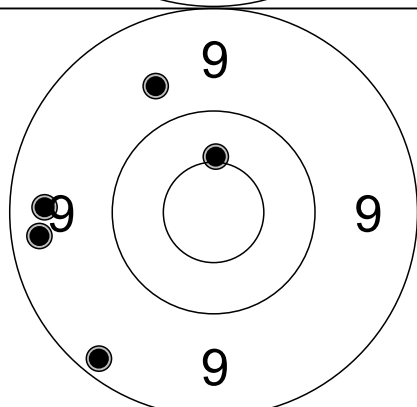

1	9.3	↘	
2	9.4	←	
3	*.5	↑	
4	9.7	↗	
5	9.4	←	

Serie 2  
S-10: 46                      SUM: 46 (1)                      TOT: 84 (1)

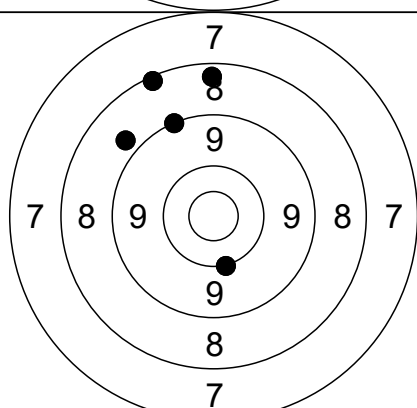

1	8.8	↖	
2	9.1	↗	
3	X.1	↓	
4	8.2	↗	
5	8.4	↑	

Serie 3  
S-10: 43                      SUM: 43 (0)                      TOT: 127 (1)

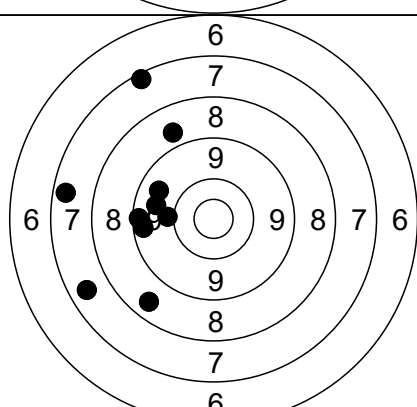

1	9.4	←	6	9.3	←
2	9.6	↖	7	9.6	←
3	8.8	↗	8	7.5	↖
4	X.0	←	9	8.5	↘
5	7.4	←	10	7.2	↗

10-skudd  
S-10: 83                      SUM: 83 (0)                      TOT: 210 (1)

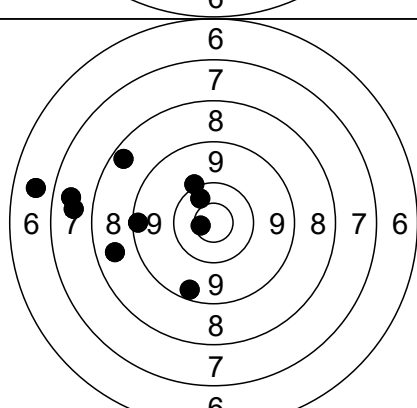

1	6.7	←	6	7.7	←
2	8.6	←	7	X.0	↗
3	9.4	↘	8	7.6	←
4	X.4	↗	9	9.2	←
5	8.4	↖	10	*.8	←

Omgang  
S-10: 84                      SUM: 84 (1)                      TOT: 294 (2)

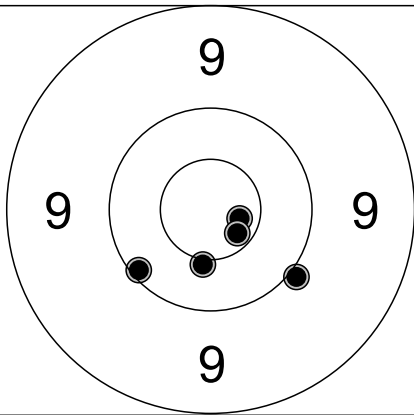

1	*.8	→	
2	*.7	↘	
3	X.0	↘	
4	X.2	↙	
5	*.5	↓	

Serie 1  
S-10: 50                      SUM: 50 (3)                      TOT: 50 (3)

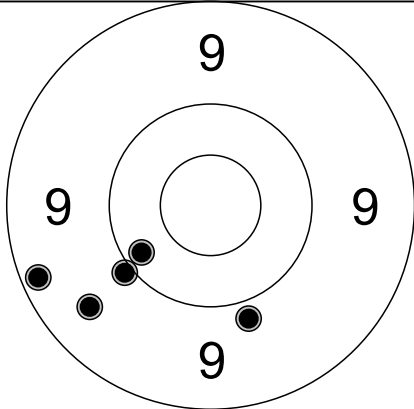

1	9.5	↙	
2	9.9	↓	
3	9.3	←	
4	X.0	↙	
5	X.3	↙	

Serie 2  
S-10: 47                      SUM: 47 (0)                      TOT: 97 (3)

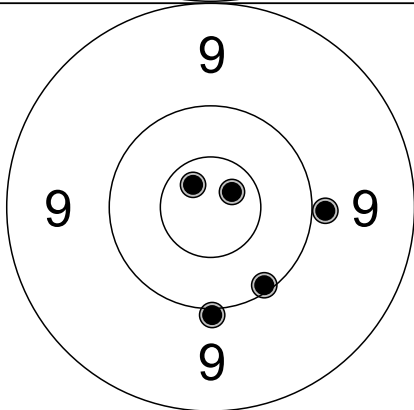

1	X.0	→	
2	*.8	↗	
3	*.8	↖	
4	X.0	↓	
5	X.2	↘	

Serie 3  
S-10: 50                      SUM: 50 (2)                      TOT: 147 (5)

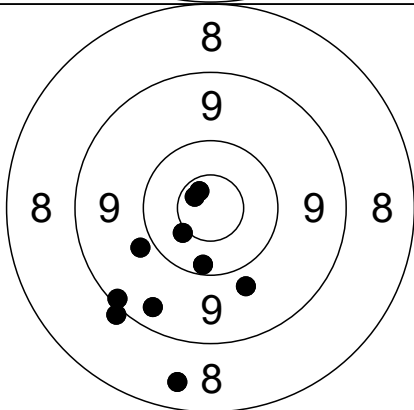

1	9.4	↙	6	8.5	↓	
2	X.2	↓	7	*.8	↖	
3	9.8	↓	8	9.2	↙	
4	9.9	↙	9	*.5	↙	
5	9.0	↙	10	*.8	↖	

10-skudd  
S-10: 93                      SUM: 93 (3)                      TOT: 240 (8)

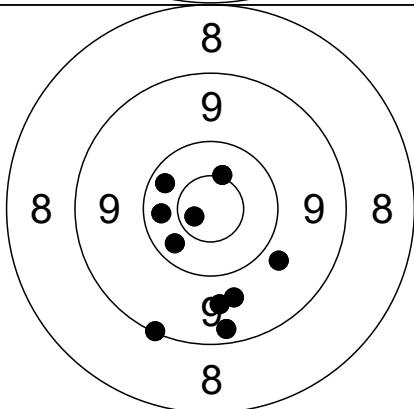

1	X.3	↖	6	9.1	↙	
2	X.4	↙	7	*.6	↗	
3	9.3	↓	8	X.4	←	
4	9.7	↓	9	*.8	↙	
5	9.7	↓	10	9.8	↘	

Omgang  
S-10: 95                      SUM: 95 (2)                      TOT: 335 (10)

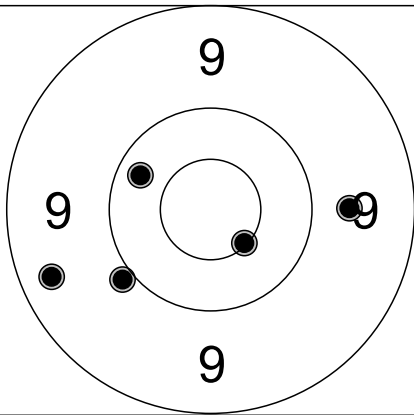

1	9.4	←	
2	X.3	↖	
3	X.0	↙	
4	*.6	↘	
5	9.7	→	

Serie 1  
S-10: 48 SUM: 48 (1) TOT: 48 (1)

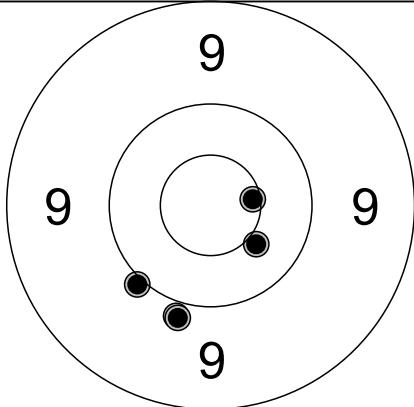

1	X.0	↓	
2	*.7	→	
3	9.9	↓	
4	*.5	↘	
5	X.0	↙	

Serie 2  
S-10: 49 SUM: 49 (2) TOT: 97 (3)

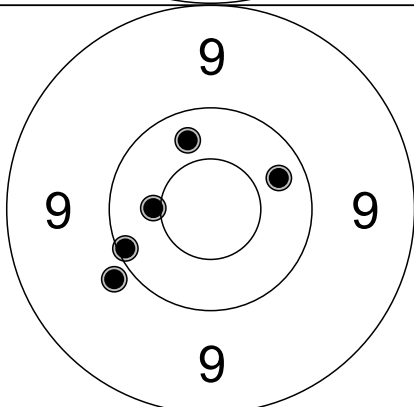

1	X.4	↗	
2	X.2	←	
3	9.9	↙	
4	X.4	↑	
5	*.5	←	

Serie 3  
S-10: 49 SUM: 49 (1) TOT: 146 (4)

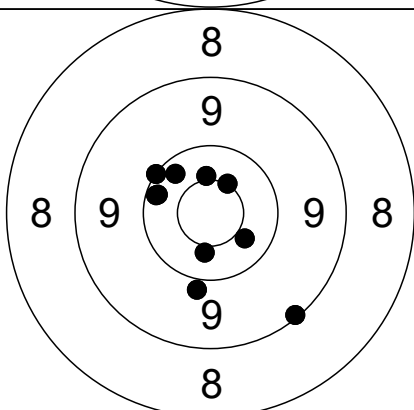

1	X.1	↖	6	9.9	↓
2	X.3	←	7	*.5	↓
3	X.2	←	8	9.1	↘
4	*.6	↗	9	*.5	↘
5	X.3	↖	10	*.5	↑

10-skudd  
S-10: 98 SUM: 98 (4) TOT: 244 (8)

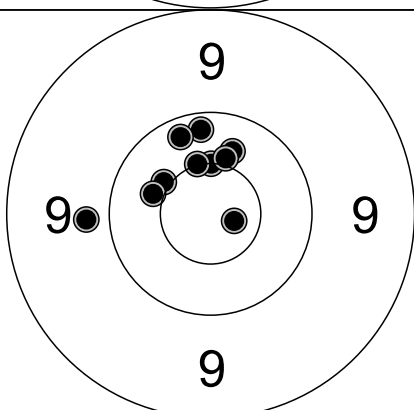

1	X.4	↑	6	*.8	→
2	*.6	↑	7	X.3	↑
3	*.5	↑	8	9.9	←
4	*.6	↑	9	X.3	↑
5	*.5	↖	10	*.5	←

Omgang  
S-10: 99 SUM: 99 (6) TOT: 343 (14)

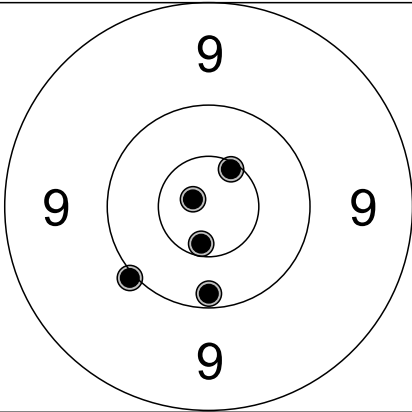

1	*.7	↗	
2	*.9	←	
3	*.7	↓	
4	X.0	↙	
5	X.2	↓	

Serie 1  
S-10: 50                      SUM: 50 (3)                      TOT: 50 (3)

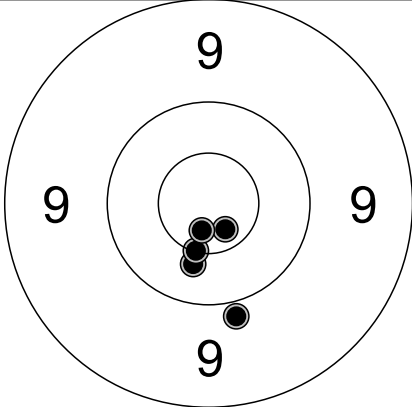

1	*.8	↓	
2	9.9	↓	
3	*.5	↓	
4	*.6	↓	
5	*.8	↓	

Serie 2  
S-10: 49                      SUM: 49 (4)                      TOT: 99 (7)

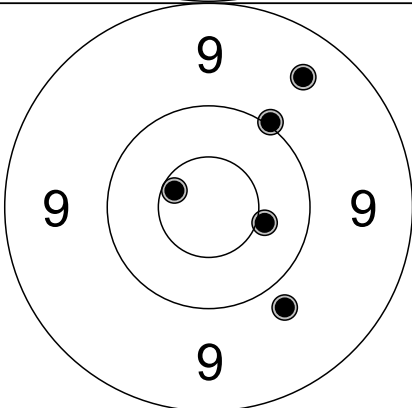

1	9.5	↗	
2	*.7	←	
3	X.1	↗	
4	*.5	→	
5	9.9	↓	

Serie 3  
S-10: 48                      SUM: 48 (2)                      TOT: 147 (9)

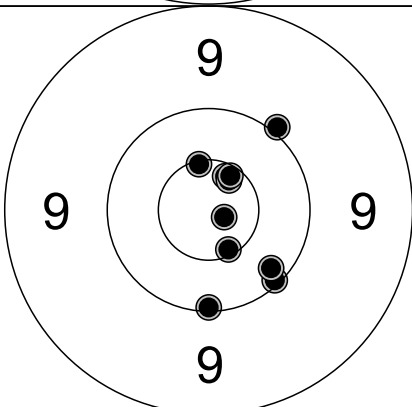

1	X.0	↗	6	X.1	↓
2	*.7	↗	7	*.7	↓
3	*.7	↗	8	X.1	↓
4	*.7	↗	9	*.6	↑
5	*.9	→	10	X.2	↓

10-skudd  
S-10: 100                      SUM: 100 (6)                      TOT: 247 (15)

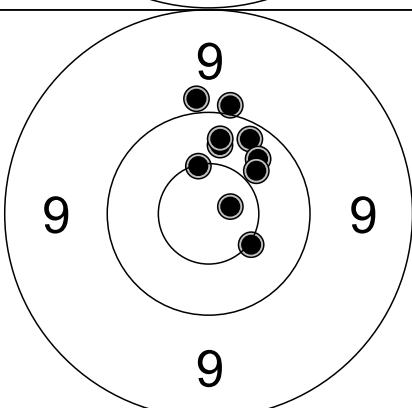

1	*.6	↑	6	X.4	↑
2	X.2	↑	7	*.9	→
3	X.4	↑	8	X.3	↑
4	X.0	↑	9	X.0	↑
5	*.5	↗	10	*.6	↓

Omgang  
S-10: 100                      SUM: 100 (4)                      TOT: 347 (19)



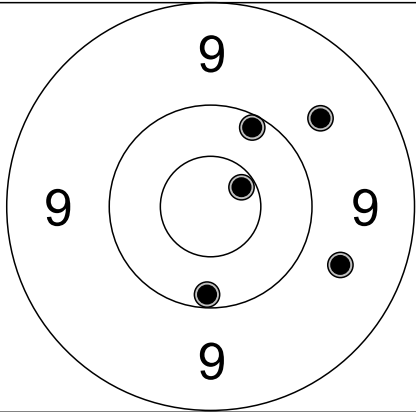

1	9.7	→	
2	*.7	↗	
3	X.2	↗	
4	9.7	↗	
5	X.2	↓	

Serie 1  
S-10: 48                      SUM: 48 (1)                      TOT: 48 (1)

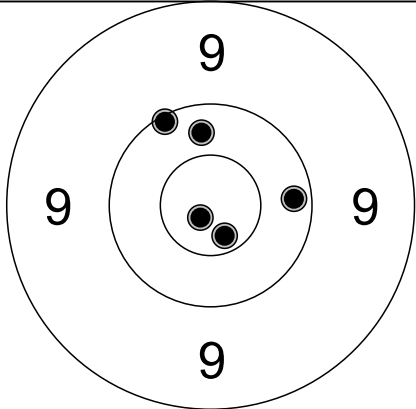

1	*.9	↙	
2	X.4	↑	
3	X.3	→	
4	X.2	↖	
5	*.8	↘	

Serie 2  
S-10: 50                      SUM: 50 (2)                      TOT: 98 (3)

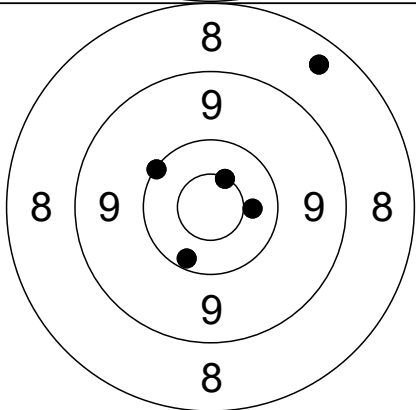

1	8.5	↗	
2	*.6	↗	
3	X.1	↖	
4	X.3	↘	
5	*.5	→	

Serie 3  
S-10: 48                      SUM: 48 (2)                      TOT: 146 (5)

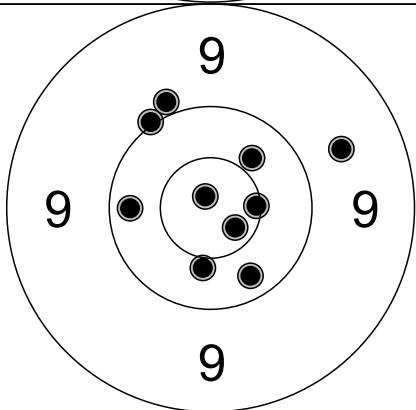

1	*.6	→	6	X.3	↘	
2	*.5	↗	7	9.7	↗	
3	X.0	↑	8	X.3	←	
4	*.9	↖	9	*.8	↘	
5	X.1	↖	10	*.5	↓	

10-skudd  
S-10: 99                      SUM: 99 (5)                      TOT: 245 (10)

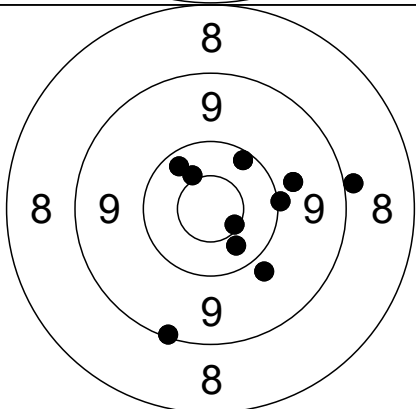

1	*.5	↖	6	9.9	↘	
2	X.1	→	7	X.4	↘	
3	9.0	→	8	*.7	↘	
4	X.2	↗	9	9.8	↗	
5	X.3	↖	10	9.1	↓	

Omgang  
S-10: 96                      SUM: 96 (2)                      TOT: 341 (12)

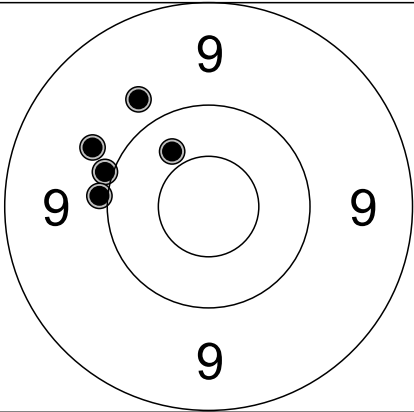

1	9.8	↗	
2	X.0	←	
3	X.4	↗	
4	X.0	←	
5	9.8	↖	

Serie 1  
S-10: 48                      SUM: 48 (0)                      TOT: 48 (0)

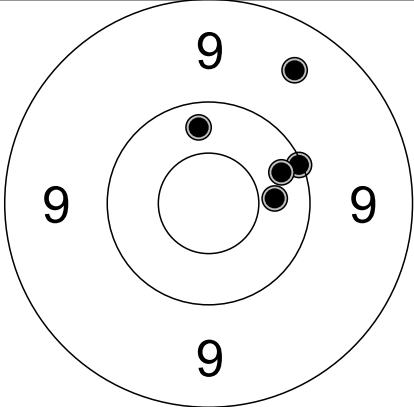

1	X.4	→	
2	X.1	→	
3	9.5	↗	
4	X.3	↑	
5	X.3	→	

Serie 2  
S-10: 49                      SUM: 49 (0)                      TOT: 97 (0)

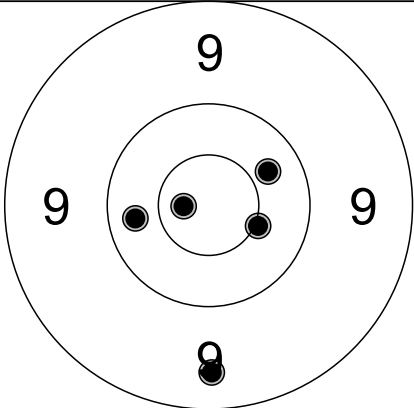

1	*.8	←	
2	*.6	→	
3	9.4	↓	
4	X.4	←	
5	X.4	↗	

Serie 3  
S-10: 49                      SUM: 49 (2)                      TOT: 146 (2)

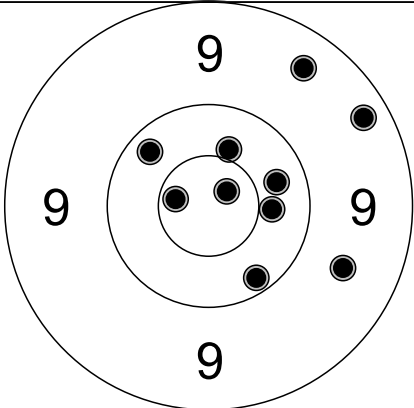

1	*.5	→		6	*.8	←	
2	9.6	→		7	*.5	↗	
3	X.4	→		8	*.9	↗	
4	9.4	↗		9	9.3	↗	
5	X.2	↓		10	X.3	↖	

10-skudd  
S-10: 97                      SUM: 97 (4)                      TOT: 243 (6)

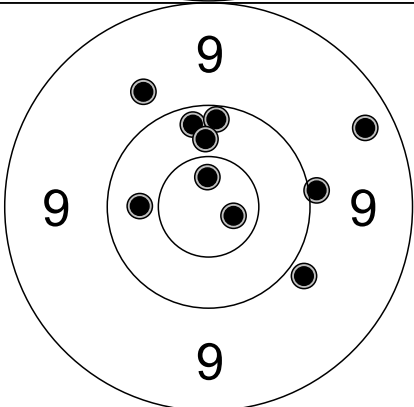

1	X.3	↑		6	9.4	↗	
2	9.8	↗		7	*.8	↑	
3	9.9	↘		8	X.0	→	
4	*.8	→		9	X.4	←	
5	X.2	↑		10	X.4	↑	

Omgang  
S-10: 97                      SUM: 97 (2)                      TOT: 340 (8)

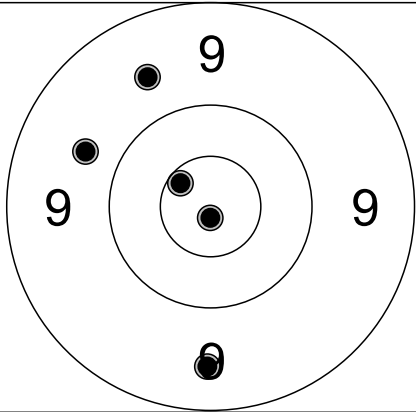

1	9.7	←	
2	*.7	↖	
3	9.5	↓	
4	9.7	↗	
5	*.9	↓	

Serie 1  
S-10: 47                      SUM: 47 (2)                      TOT: 47 (2)

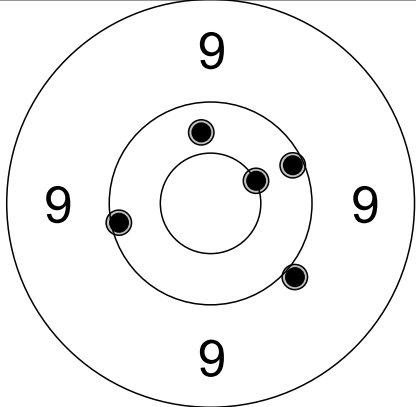

1	X.0	↘	
2	X.2	→	
3	X.2	←	
4	X.4	↑	
5	*.6	↗	

Serie 2  
S-10: 50                      SUM: 50 (1)                      TOT: 97 (3)

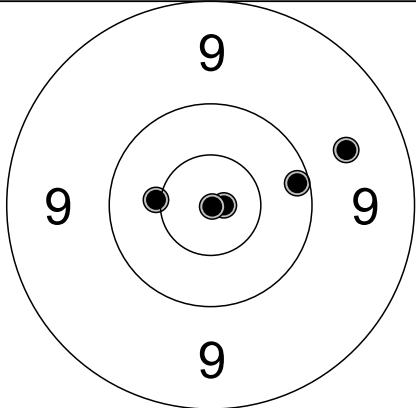

1	*.5	←	
2	*.9	→	
3	*.9	○	
4	9.7	↗	
5	X.2	→	

Serie 3  
S-10: 49                      SUM: 49 (3)                      TOT: 146 (6)

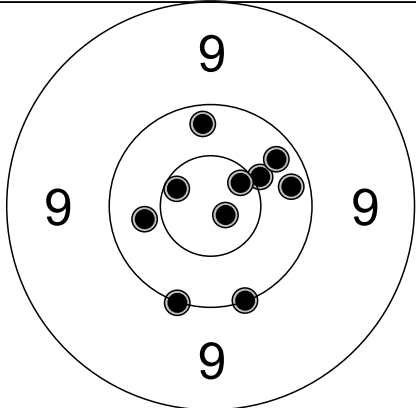

1	*.7	←		6	*.9	↘	
2	X.3	↑		7	X.3	→	
3	*.5	↗		8	*.7	↗	
4	X.1	↓		9	X.3	↗	
5	X.4	←		10	X.1	↓	

10-skudd  
S-10: 100                      SUM: 100 (4)                      TOT: 246 (10)

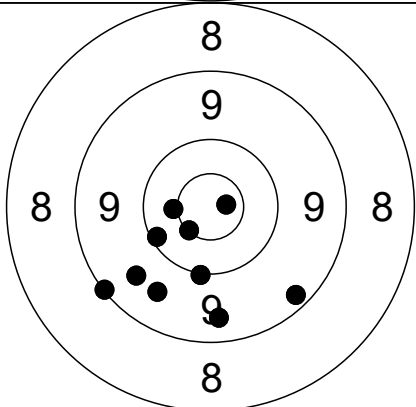

1	*.9	→		6	*.6	↙	
2	9.6	↙		7	X.1	↓	
3	*.5	←		8	X.2	↙	
4	9.5	↓		9	9.6	↙	
5	9.1	↙		10	9.3	↘	

Omgang  
S-10: 95                      SUM: 95 (3)                      TOT: 341 (13)

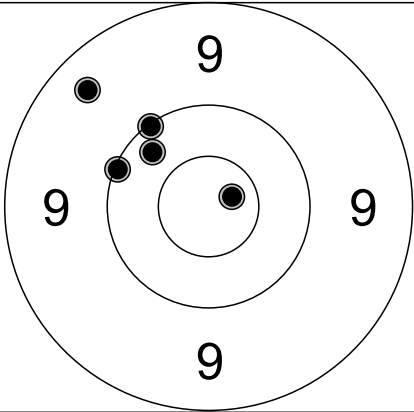

1	9.4	↖	
2	X.1	↖	
3	X.3	↖	
4	X.1	↖	
5	*.8	→	

Serie 1  
S-10: 49                      SUM: 49 (1)                      TOT: 49 (1)

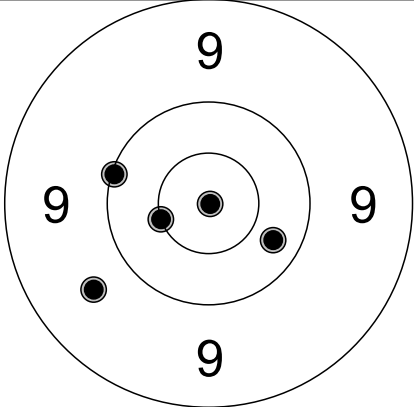

1	*.9	○	
2	X.1	←	
3	9.7	↙	
4	X.4	→	
5	*.6	←	

Serie 2  
S-10: 49                      SUM: 49 (2)                      TOT: 98 (3)

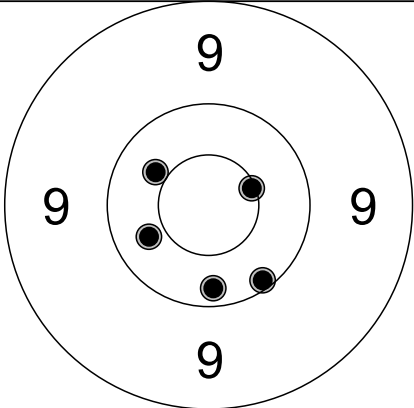

1	*.6	→	
2	*.5	↖	
3	X.2	↘	
4	X.4	←	
5	X.3	↓	

Serie 3  
S-10: 50                      SUM: 50 (2)                      TOT: 148 (5)

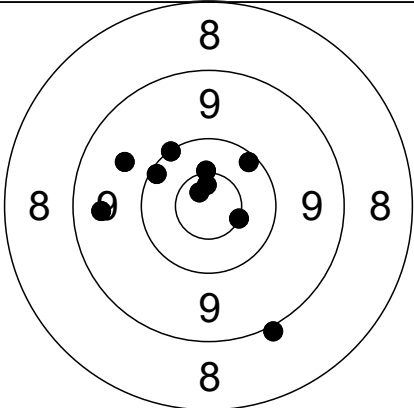

1	X.2	↖		6	9.5	←	
2	9.7	↖		7	X.1	↖	
3	*.8	↖		8	*.6	→	
4	*.8	↑		9	X.2	↖	
5	*.6	↑		10	9.0	↓	

10-skudd  
S-10: 97                      SUM: 97 (4)                      TOT: 245 (9)

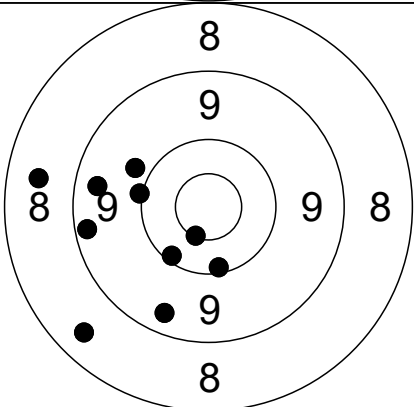

1	8.6	←		6	9.4	↘	
2	9.9	↖		7	X.2	↓	
3	9.4	←		8	X.2	↘	
4	X.1	←		9	*.6	↘	
5	9.3	←		10	8.5	↘	

Omgang  
S-10: 92                      SUM: 92 (1)                      TOT: 337 (10)

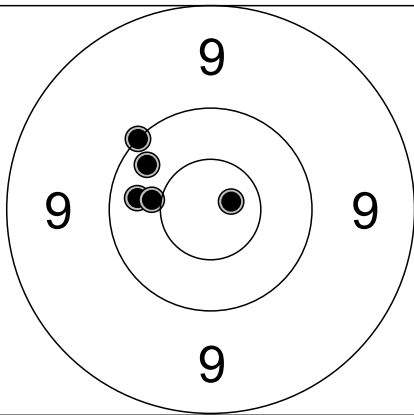

1	X.3	↖	
2	*.9	→	
3	X.1	↖	
4	X.4	←	
5	*.5	←	

Serie 1  
S-10: 50                      SUM: 50 (2)                      TOT: 50 (2)

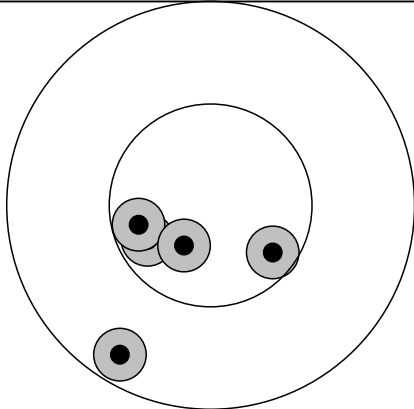

1	*.7	↘	
2	*.7	←	
3	*.7	←	
4	*.8	↘	
5	X.2	↘	

Serie 2  
S-10: 50                      SUM: 50 (4)                      TOT: 100 (6)

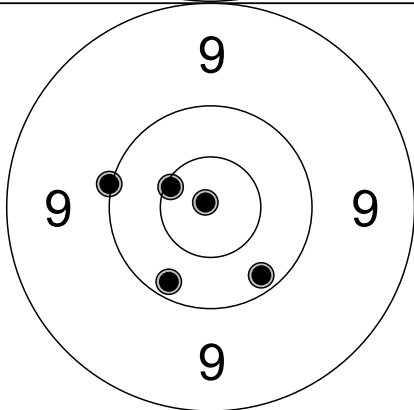

1	*.9	↖	
2	*.6	↖	
3	X.2	↘	
4	X.1	←	
5	X.3	↘	

Serie 3  
S-10: 50                      SUM: 50 (2)                      TOT: 150 (8)

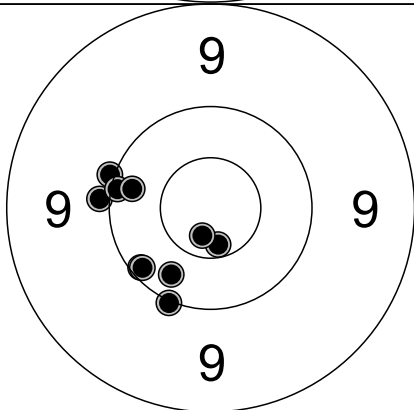

1	X.3	↘	6	X.0	←	
2	*.7	↘	7	*.8	↘	
3	X.0	←	8	X.2	←	
4	X.1	↘	9	X.3	←	
5	X.2	↖	10	X.2	↘	

10-skudd  
S-10: 100                      SUM: 100 (2)                      TOT: 250 (10)

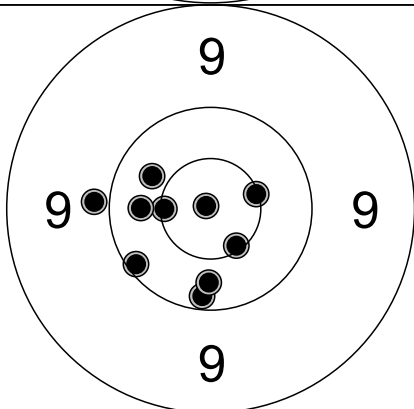

1	*.6	↘	6	X.2	↓	
2	*.6	←	7	9.9	←	
3	X.4	↖	8	X.2	↖	
4	*.6	→	9	X.4	↓	
5	*.9	↖	10	X.4	←	

Omgang  
S-10: 99                      SUM: 99 (4)                      TOT: 349 (14)

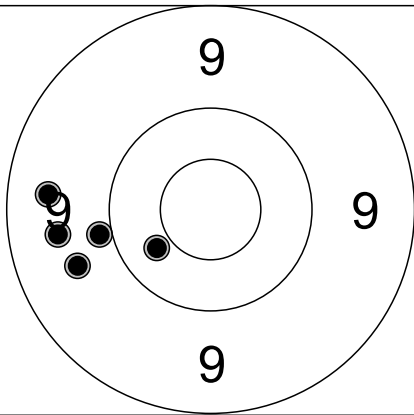

1	9.7	←	
2	9.5	←	
3	X.0	←	
4	X.4	↙	
5	9.6	←	

Serie 1  
S-10: 47                      SUM: 47 (0)                      TOT: 47 (0)

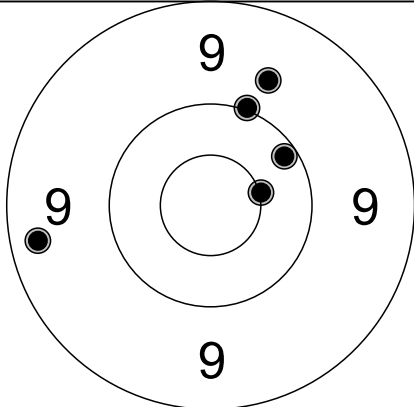

1	9.4	←	
2	X.2	↗	
3	X.1	↑	
4	*.6	→	
5	9.7	↑	

Serie 2  
S-10: 48                      SUM: 48 (1)                      TOT: 95 (1)

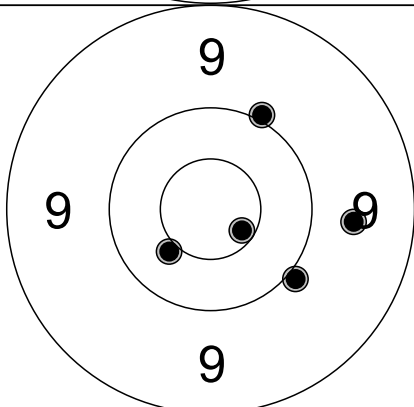

1	X.0	↗	
2	X.0	↘	
3	*.5	↙	
4	9.7	→	
5	*.7	↘	

Serie 3  
S-10: 49                      SUM: 49 (2)                      TOT: 144 (3)

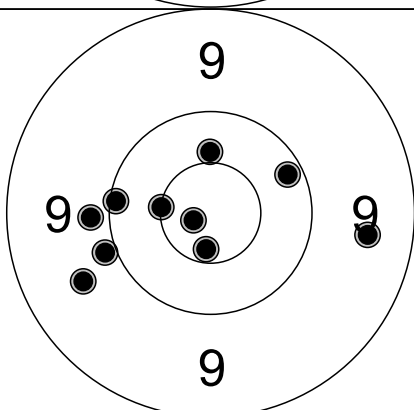

1	9.7	←	6	X.2	↗
2	*.7	↓	7	X.0	←
3	X.2	←	8	*.9	←
4	*.5	↑	9	9.5	→
5	*.6	←	10	9.9	←

10-skudd  
S-10: 97                      SUM: 97 (4)                      TOT: 241 (7)

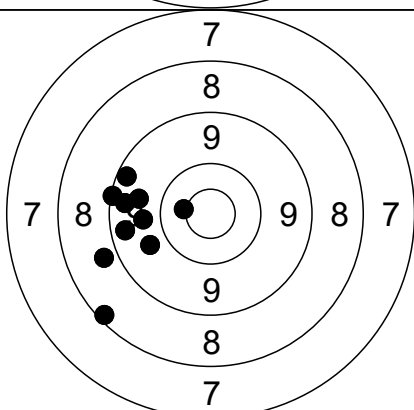

1	9.8	←	6	9.8	←
2	9.7	←	7	9.1	←
3	8.2	↙	8	8.8	←
4	*.6	←	9	9.4	←
5	9.4	←	10	9.3	↙

Omgang  
S-10: 89                      SUM: 89 (1)                      TOT: 330 (8)

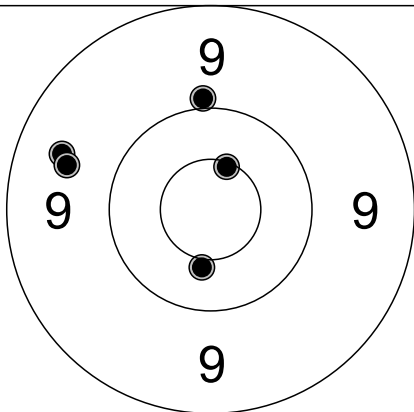

1	9.5	←	
2	*.6	↑	
3	X.0	↑	
4	*.5	↓	
5	9.6	←	

Serie 1  
S-10: 48                      SUM: 48 (2)                      TOT: 48 (2)

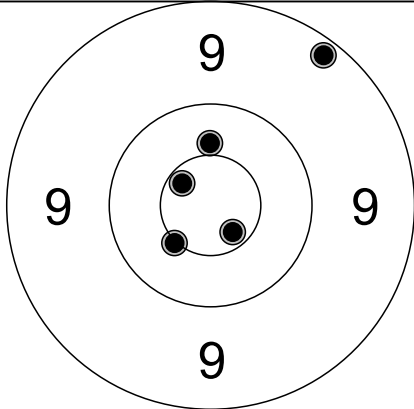

1	*.7	↖	
2	*.6	↙	
3	*.7	↘	
4	9.3	↗	
5	*.5	↑	

Serie 2  
S-10: 49                      SUM: 49 (4)                      TOT: 97 (6)

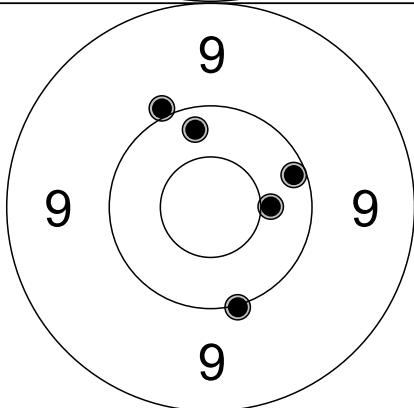

1	*.5	→	
2	X.2	→	
3	X.1	↓	
4	X.3	↑	
5	X.0	↖	

Serie 3  
S-10: 50                      SUM: 50 (1)                      TOT: 147 (7)

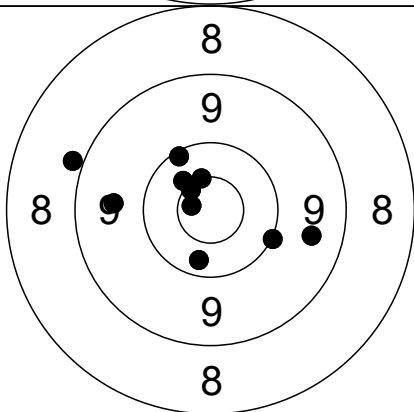

1	*.5	↖	6	8.9	←	
2	X.2	↖	7	X.3	↓	
3	*.7	↖	8	9.7	←	
4	*.6	↑	9	*.8	←	
5	9.6	→	10	X.1	→	

10-skudd  
S-10: 96                      SUM: 96 (4)                      TOT: 243 (11)

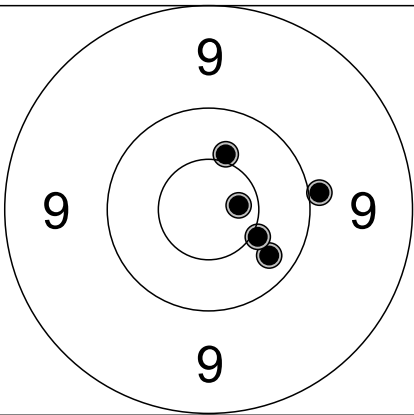

1	X.3	↘	
2	*.5	↘	
3	X.0	→	
4	*.5	↑	
5	*.8	→	

Serie 1  
S-10: 50                      SUM: 50 (3)                      TOT: 50 (3)

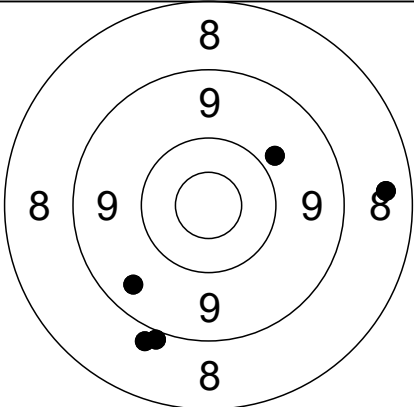

1	8.5	→	
2	9.9	↗	
3	8.9	↓	
4	9.0	↓	
5	9.5	↙	

Serie 2  
S-10: 43                      SUM: 43 (0)                      TOT: 93 (3)

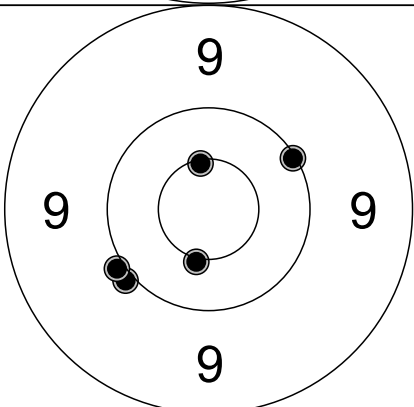

1	*.6	↑	
2	X.0	↙	
3	X.1	↗	
4	*.6	↓	
5	X.0	↙	

Serie 3  
S-10: 50                      SUM: 50 (2)                      TOT: 143 (5)

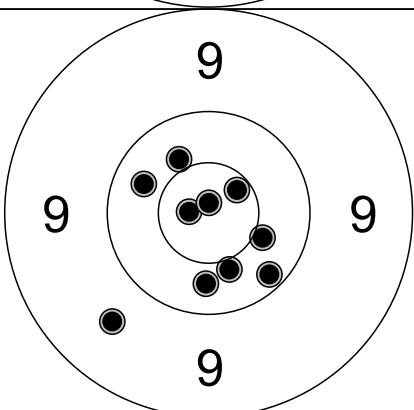

1	X.4	↖	6	X.4	↓
2	*.5	↑	7	X.2	↘
3	9.7	↙	8	*.5	↓
4	*.5	→	9	*.9	↑
5	*.9	↖	10	*.7	↗

10-skudd  
S-10: 99                      SUM: 99 (6)                      TOT: 242 (11)

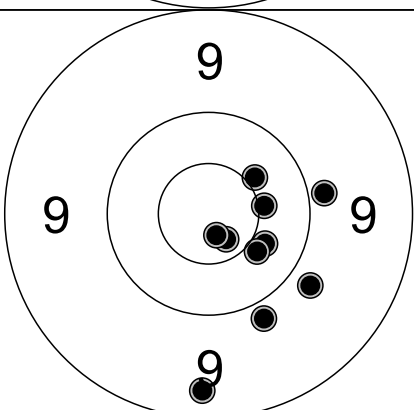

1	9.9	→	6	*.5	↘
2	9.9	↓	7	*.8	↘
3	*.5	→	8	*.9	↓
4	*.5	↘	9	*.5	↗
5	9.9	↘	10	9.4	↓

Omgang  
S-10: 96                      SUM: 96 (6)                      TOT: 338 (17)



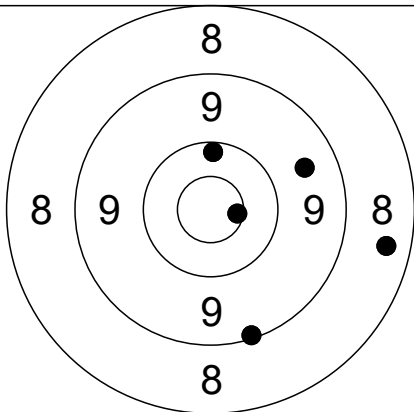

1	9.6	→	
2	*.7	→	
3	X.2	↑	
4	9.1	↓	
5	8.5	→	

Serie 1  
S-10: 46 SUM: 46 (1) TOT: 46 (1)

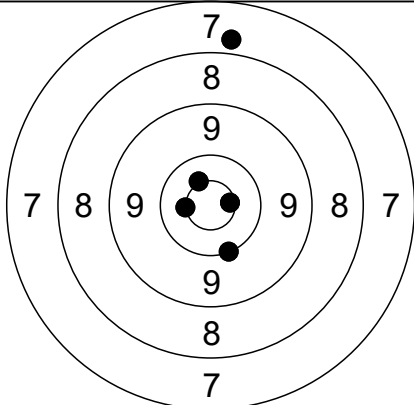

1	X.1	↓	
2	*.6	↖	
3	*.7	→	
4	7.8	↑	
5	*.6	←	

Serie 2  
S-10: 47 SUM: 47 (3) TOT: 93 (4)

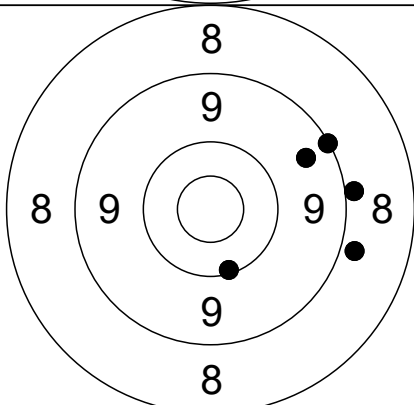

1	9.0	→	
2	X.2	↓	
3	9.5	↗	
4	9.1	↗	
5	8.9	→	

Serie 3  
S-10: 45 SUM: 45 (0) TOT: 138 (4)

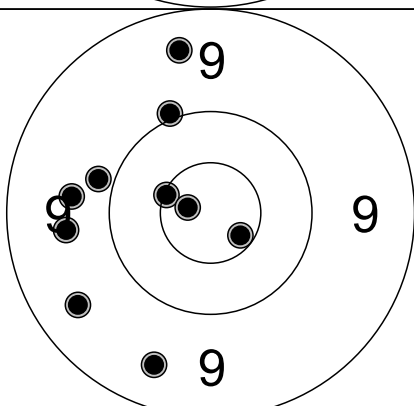

1	9.5	↑	6	*.7	↘	
2	9.5	↙	7	X.0	↑	
3	*.6	←	8	9.9	←	
4	9.7	←	9	9.5	↓	
5	*.9	←	10	9.7	←	

10-skudd  
S-10: 94 SUM: 94 (3) TOT: 232 (7)

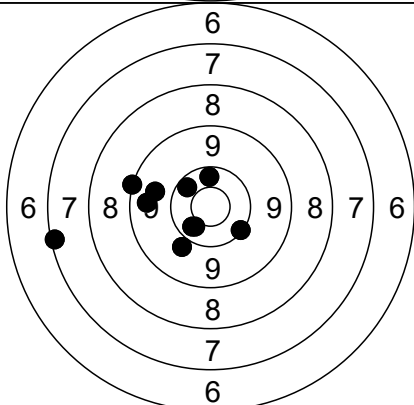

1	*.5	↙	6	9.1	←	
2	9.5	←	7	X.4	↙	
3	X.3	↖	8	X.3	↑	
4	X.2	↘	9	7.2	←	
5	9.7	←	10	9.9	↙	

Omgang  
S-10: 93 SUM: 93 (1) TOT: 325 (8)